



... MOVING AHEAD

Quality Chains

Roller Chains

Offset Sidebar Chains

Leaf Chains

Contents

	Rexnord Quality Features	6 – 7
	Comments on correct Chain Selection	8 – 9
	Roller Chains BS, European Standard, DIN 8187/ISO 606	10 – 11
	Roller Chains ANSI, American Standard, DIN 8188	12 – 15
	Roller Chains ANSI, American Standard, H-Series	16 – 17
	Roller Chains ANSI, American Standard, HE-Series	18 – 19
	Roller Chains, Industry Standard	20
	Roller Chains without Rollers for Lifting Applications and Stone Drilling Machinery	21
	Roller Chains for Heavy Drives and Lifting Applications	21
	Holsting Chains for Straddle Carriers	21
	Roller Chains with Straight Link Plates	21
	Roller Chains with Thermoplastic Bearings	22
	Hollow Pin Chains	23
	Stainless Steel Roller Chains	24
	Side Bow Roller Chains	25
	Double-Pitch Roller Chains with Straight Link Plates, American Standard	26
	Double-Pitch Roller Chains with Straight Link Plates and Carrier Rollers, American Standard	27
	Double-Pitch Roller Chains, European Standard, DIN 8181	27
	Double-Pitch Roller Chains, American Standard	27
	Agricultural Roller Chains, ISO 487, DIN 8189	28
	Agricultural Roller Chains, Industry Standard	29
	Agricultural Roller Chains with Thermoplastic Bearings	29
	Leaf Chains acc. to DIN 8152, American Standard, Heavy Series	30 – 31
	Leaf Chains acc. to DIN 8152, European Standard, Light Series	32 – 33
	Leaf Chains, American Standard, Light Series	32 – 33
	Leaf Chains, Industry Standard	32
	Fastening of Leaf Chains	34 – 36
	Endplates for Leaf Chains	36
	Offset Sidebar Chains	37
	Laschenkettten	38 – 39
	Marine Diesel Roller Chains	40 – 41
	Fastening Dimensions for Roller Chains, European Standard, DIN 8187	42
	Fastening Dimensions for Roller Chains, American Standard, DIN 8188	42
	Proper and Improper Lubrication of Roller Chains	43 – 46
	Recommendations for Use	47 – 49

Reproduction in whole or parts of this catalogue is prohibited without or specific permission.

In accordance with the policy of Rexnord to constantly improve its products the specifications in this catalogue are subject to change without notice.

Design: Advertising Department Rexnord Kette, Betzdorf, Germany

Rexnord Quality Chains – world wide

Since 1892 Rexnord has been manufacturing chains in many different designs. The experience gained in many decades, as well as consistent research, ensure products of advanced design and numerous application possibilities. Rexnord manufactures in 6 plants and 3 continents.

The numerous patents confirm the extraordinary innovation of our company. Wherever applications of extreme high quality are required, Rexnord products are preferred.



Betzdorf/Sieg General Headquarters and Factory.

Think like partners – act like partners

Speed

The speed with which modern technologies change our world is breathtaking.

For us two aims are certain:

We are determined, with our products for our customers, to occupy a leading position as regards technology.

We want, together with our customers, to achieve quality and sales growth.

Consulting

Our application engineers concentrate on the customer's interests.

We concentrate on the individual wishes and needs of the customer when calculating and identifying the correct chain drive.

Together with our customers, we find solutions, which optimize the factors of safety, service life and price.

Partnership

We know what the customer needs in his market for his product in the future.

We listen to you and observe driving and conveying world-wide. We carry out analyses on the customer's premises and apply practicable solutions. So that you remain competitive.

Service

We are only satisfied when you are.

We have created the conditions for this by means of intensive consulting, partnership and our own sales activities. Thus there is a combination of our market know-how, technical competence, customer service and the satisfaction of our customers.



No matter where, no matter when,
meeting the customer on the spot.

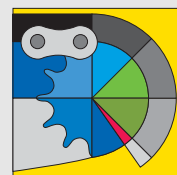
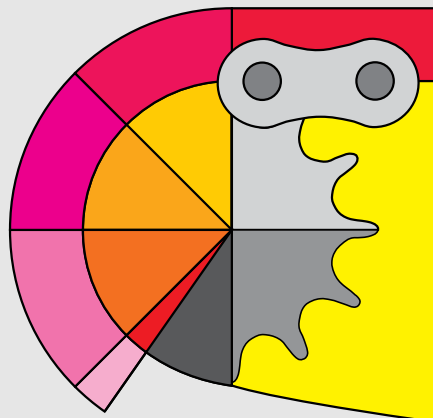
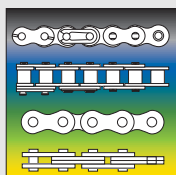

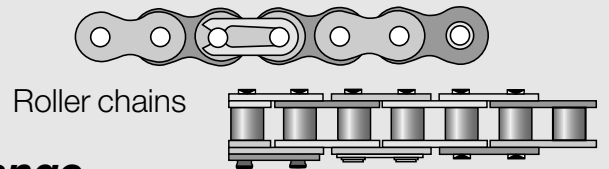
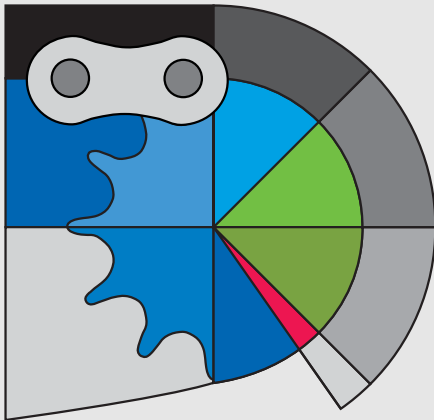

Roller chains

Product range

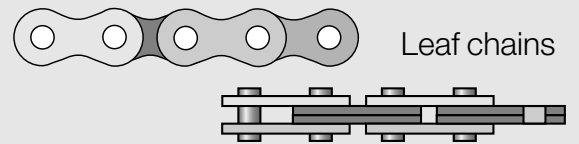

Leaf chains

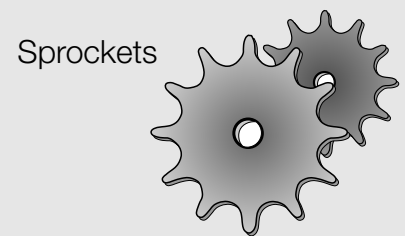

Sprockets

Competence

As the manufacturer of one of the most extensive chain ranges for drives and conveying we are an established partner of leading companies. Our 5,000 chain variants provide an impressively large number of solutions and flexibility.

Innovation

The secret lies in the production methods and the material.

Several thousand tools developed by ourselves rotate in the flow of production.

650 special tools were constructed by us for the manufacture of special chains.

30 special steels, alloyed, stainless, patented, are processed.

Moreover, we offer many different lubrications.

Through our customers we have become a specialist in surface refinement and the heat treatment of steel.

Quality

For Rexnord means that the customer comes back and not the chain.

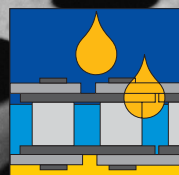
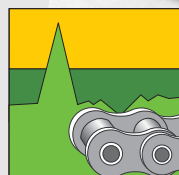
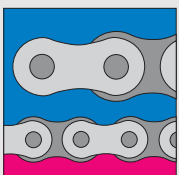

Rexnord Methods of Production Towards Optimizing Quality

High Case Hardness

The pins and bushes that constitute the chain bearing area are furnished with an optimally deep hardness layer. This stratum contributes essentially to the life span. Surface hardness is approximately 60 HRC.



High Case and Depth Hardness.

Ball-Drifting

Ball-drifting of the plate bores serves to achieve strain-hardening of the material. All punching flutes and sharp edges are simultaneously removed. Press fits and fatigue strength are so optimally improved.

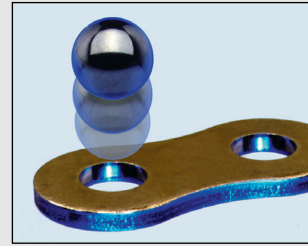

Ball-Drifting.

Shot Peening

All plates, bushes and rollers are shot peened for further improving fatigue resistance. This effective cold processing moreover consolidates the surfaces and increases their load-bearing properties. Such parts have a built-in tension and therefore higher resistance against loading.

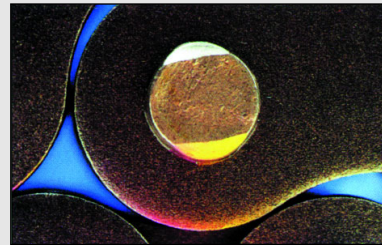

Shot Peening.

Shock-Resistant Rollers

Rexnord Rollers are produced to high precision, of a uniform wall thickness and absolutely free from any taper. An optimal seating and smooth running is so warranted. The Rollers are shot-peened and possess a high fatigue strength for resisting running-in impacts.

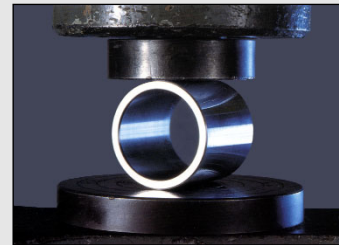

Shock-Resistant Rollers.

Pre-Loading

Rexnord Roller Chains are "pre-run-in" under high load. Customary chain run-in elongation is thereby minimized and expensive tensioning in application avoided. All Chains are subjected to a severe length control. High pre-loading enhances their load-bearing property and reliability.

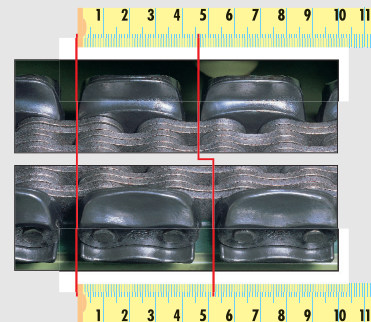

Pre-Loading.

Uniform Quality

The uniform quality of Rexnord chains is not merely ensured by initial and final inspections, but far more, also by in-process routine testing of the individual elements.

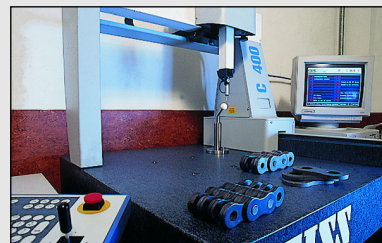

Uniform Quality.

Advantages of Rexnord Chains

Contrary to widespread opinion, the breaking load of a chain is not an indicator of resistance to fatigue and long wear life.

Therefore, chains manufactured to specified standards, and with equal breaking loads, differ in quality from manufacturer to manufacturer.

Important for quality are fatigue strength and wear resistance.

Special manufacturing techniques developed by Rexnord formulate such factors as fatigue resistance, wear resistance and tensile strength to provide their optimum combination.



This jig boring machine plays a large role in the precision of the Rexnord chain tools.

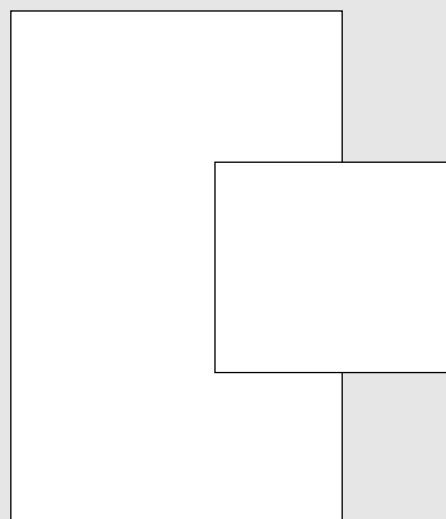

For the testing of fatigue strength, we use, among others, this – designed according to the latest technological knowledge – high frequency fatigue testing machine.

Quality Management System

Rexnord Kette GmbH & Co. KG employs a quality management system which is reflected in the special commitments to our customers.

The quality management handbook contains the quality management system from Rexnord Kette GmbH & Co. KG.

Thereby all our customers have access to the information how Rexnord realises and guarantees its products.

We wish to provide all our colleagues with some helpful guidelines, which will help to support and motivate them in their endeavours to work with quality consciousness.

Contents:

This handbook contains an all-round binding description, which is written in 20 elements and according to the internationally known DIN EN 9001.

Therefore, the colleagues involved have access to process details, working details and testing methods as well as all-round processing practices.

Furthermore, we are constantly improving our products and organisation. Part of this improvement involves following up internal and external developments with positive interest and constant evaluation of our market.

The fruits of this policy are shown by the certification awarded according to DIN EN ISO 9001: 1994 and API Spec Q1 and Spec 7F through American Petroleum Institute

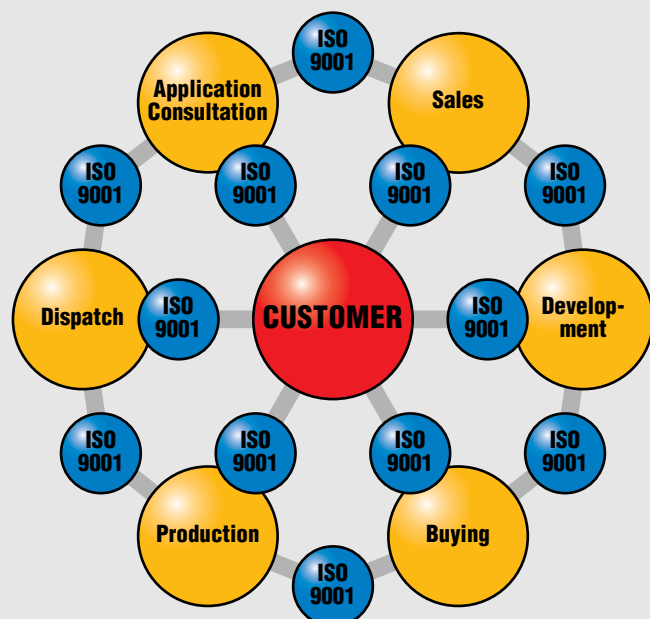

Rexnord Quality Features

Ultimate Strength

The stated value given for ultimate tensile strength is of little significance. Prior to a chain reaching its breaking point, it will start to take up a permanent deformation, which will render the chain useless before the actual breakage takes place. This permanent deformation starts at the yield point.

Yield Point

This is the point at which the elastic limit of the material is reached.

Below this yield point, loads and operational shocks cause deformation which is elastic and lasts only as long as the load effect.

The yield point is therefore of prime importance as the chain cannot resist any load above this point.

Fatigue Strength

This is the property of the chain to resist the operational and pulsating loads imposed by the polygon effect of the sprockets and load changes without metal fatigue failure.

Close control over material specifications and production methods and the balancing of these factors with the ultimate strength is necessary to achieve the optimum fatigue strength value.

If the ultimate tensile strength is increased beyond certain limits then this important fatigue strength value is decreased considerably.

Please note:

For design specifications it is the values for elasticity and fatigue strength that are of importance. If required please contact Rexnord for these values.

All values given in this catalogue are the minimum values as laid down in the DIN specification.

Average and even maximum values cannot be used for reliable design recommendations.

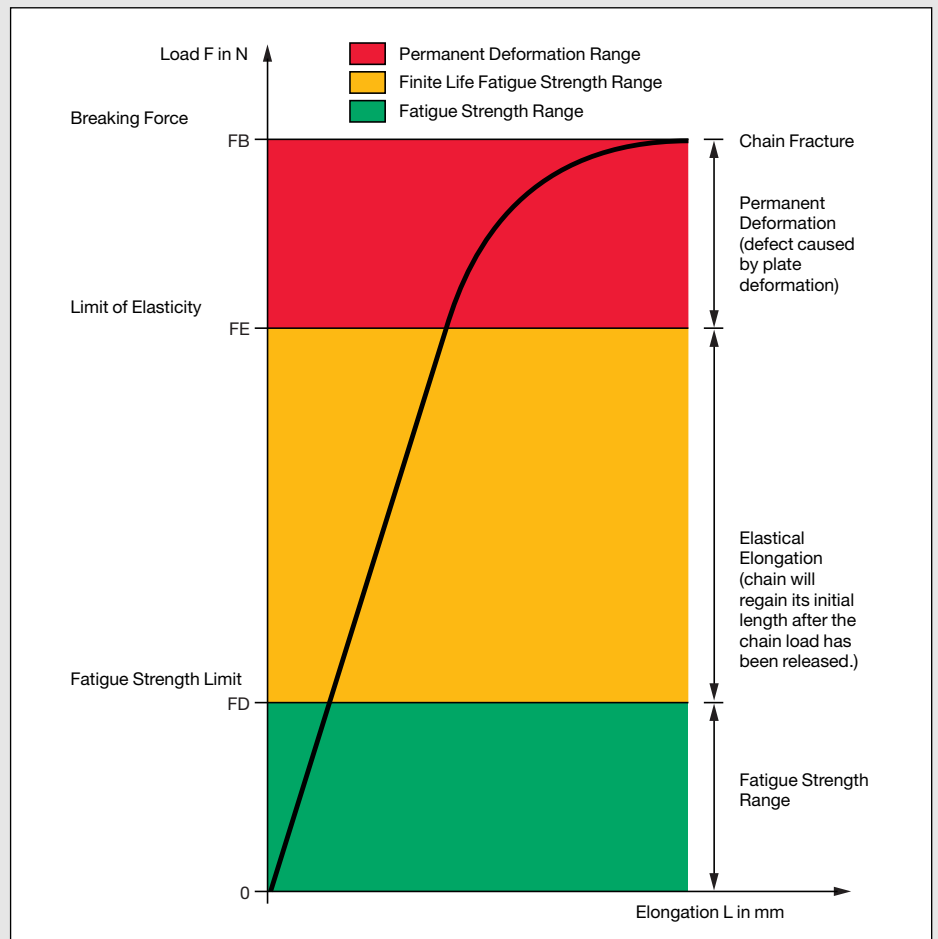

Are you aware that...

Rexnord has been producing chains since 1892.

Rexnord is well-known as a pioneer in the development of all chain types.

Rexnord is the leading manufacturer of roller, leaf, offset sidebar, TableTop and agricultural chains.

Rexnord produces chains in 6 facilities on 3 different continents.

Rexnord obtained 48 patents in total on chain developments, 21 of which were for TableTop chains.

Rexnord chain plates are ball-drifted.

Rexnord chain parts are all shot-peened.

Rexnord chain pins and bushings are especially wear resistant due to large case depths.

Rexnord chains have the advantage of an extremely high toughness since they are through-hardened.

Rexnord chains are run-in and pre-loaded.

Rexnord chains are subject to a consistent quality control by means of checking all dimensions and toughness values starting from raw material up to the final product with careful single controls at each production stage.

Comments on correct Chain Selection

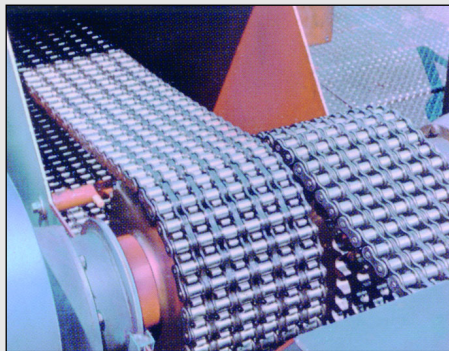

Most important for correct chain selection, are the values of bearing pressure and fatigue resistance. While the fatigue resistance determines whether the chain – during the entire wear life – is operationally safe, the bearing pressure is the most important influence on wear life.

The breaking load has no informative value for the suitability of a chain. Breaking load data is a statistically determined value. However, in the practical application, the chain load is dynamic.

The “safety” calculation of a chain – indirectly through the breaking load – and a safety factor depending on a recommendation of 3,5 (or any other factor), normally results in over or undersizing the chain size.

When fatigue resistance is the same as or larger than the load, you can be certain of a correct chain selection.

The fatigue resistance has no mathematical relationship to the breaking load. It depends entirely on the quality of the chain and the number of chain strands or the leaf chain lacing.

Chains with comparable breaking loads, and thus implying a similar quality, can have fatigue strengths that differ by as much as 100 %.

The use of multiple strand chains highlights this difference. Four simplex roller chains (or 2 x 2 leaf chain) have a fatigue resistance of more than double that of a quadruplex chain (or 8 x 8 leaf chain).

Consequently, for chains with different lacing and manufacturing quality, individually adapted safety factors, “S” (S = 4 to S = 20), must be selected. The selection of the correct safety factor will decrease the safety risk.

To ensure correct selection of your chain, contact us at Rexnord and we shall be pleased to provide the information.

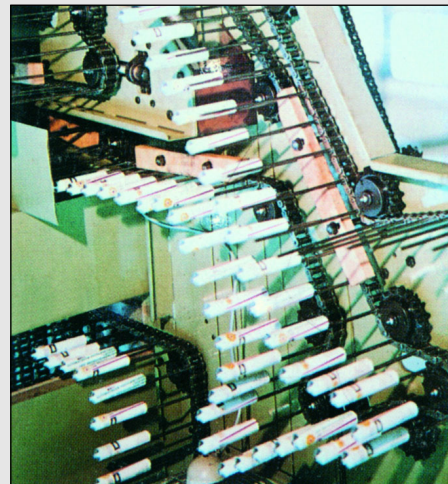

Important Note:

Only the fatigue strength is indicative of a chain’s “endurance”. The breaking force may not be relied on for determining the chain’s safety.

All so-called safety factors determined on the basis of breaking force values are misleading.



Proof:

Rexnord chains with production reference (plates with silver label).

Rexnord chains were equipped with a new plate design in 1982, by which fatigue strength was increased by approx. 25 %.

Rexnord exclusively uses refined steels – partly patented – for chain manufacturing.

Rexnord chains have got extraordinary quality features regarding wear resistance

and operating safety due to specially selected materials, newly developed manufacturing and processing techniques and critically controlled heat treatment.

Rexnord chains are absolutely reliable even during strongest permanent load, since they have up to 100 % higher fatigue strength values compared to the average..

Roller Chains, European Standard



*High Performance
Roller Chains*

Links A and B available for all chains.

- With straight link plates on page 21.
- Higher inner plate "g" = higher fatigue strength.

Roller Chains, Single Strand, DIN 8187/ISO 606

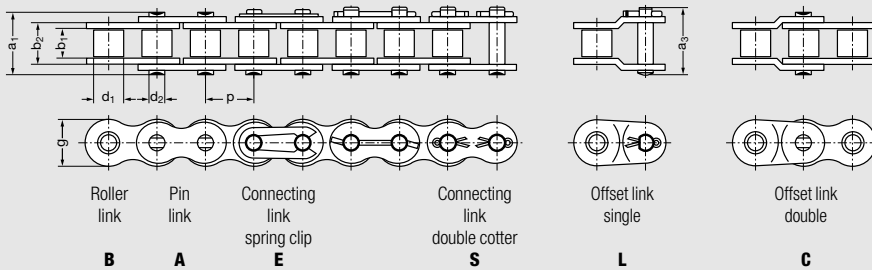

ISO- No.	Pitch p		Roller Width b ₁ min. mm	Roller Diameter d ₁ max. mm	Pin Diameter d ₂ max. mm	Inner Width b ₂ max. mm	Linkplate Height g max. mm	Trans- verse e mm	Pin Width a ₁ max. mm	Overall Width a ₃ max. mm	Bearing Area A cm ²	Required *) Ultimate Strength min. F _B N	Weight ≈ q kg/m	Loose Parts			
	inch	mm												S	C	E	L
04		6,0	2,8	4,0	1,85	4,1	5,0	–	7,4	10,3	0,08	3 000	0,12	x	x		
05 B – 1		8,0	3,0	5,0	2,31	4,77	7,1	–	8,6	11,7	0,11	5 000	0,18	x	x		
■ 06 B – 1	0,375	9,525	5,72	6,35	3,28	8,53	8,3	–	13,5	16,8	0,28	9 000	0,41	x	x		
081	0,50	12,7	3,3	7,75	3,66	5,8	9,9	–	10,2	11,7	0,21	8 200	0,28	x	x	x	
083	0,50	12,7	4,88	7,75	4,09	7,9	10,3	–	12,9	14,4	0,32	12 000	0,42	x	x	x	
084	0,50	12,7	4,88	7,75	4,09	8,8	11,1	–	14,8	16,3	0,326	16 000	0,59	x	x	x	
085	0,50	12,7	6,38	7,77	3,58	9,07	9,9	–	14,0	16,0	0,32	6 800	0,38	x	x	x	
08 B – 1	0,50	12,7	7,75	8,51	4,45	11,3	11,6	–	17,0	19,0	0,50	18 000	0,70	x	x	x	
■ 10 B – 1	0,625	15,875	9,65	10,16	5,08	13,28	14,6	–	19,6	22,0	0,67	22 400	0,90	x	x	x	
■ 12 B – 1	0,75	19,05	11,68	12,07	5,72	15,62	15,9	–	22,7	25,1	0,89	29 000	1,15	x	x	x	
■ 16 B – 1	1,00	25,4	17,02	15,88	8,28	25,4	20,5	–	36,1	42,4	2,1	60 000	2,60	x	x	x	x
■ 20 B – 1	1,25	31,75	19,56	19,05	10,19	29,0	25,7	–	40,4	47,6	2,96	95 000	3,70	x			x
■ 24 B – 1	1,50	38,1	25,4	25,4	14,63	37,9	33,0	–	53,8	60,6	5,54	160 000	6,90	x			x
28 B – 1	1,75	44,45	30,99	27,94	15,90	46,5	37,0	–	63,3	72,8	7,39	200 000	8,60	x			x
32 B – 1	2,00	50,8	30,8	29,21	17,81	45,5	41,2	–	65,1	73,6	8,1	250 000	9,50	x			x
40 B – 1	2,50	63,5	38,1	39,37	22,89	55,7	51,5	–	78,9	91,3	12,75	355 000	15,10	x			x
48 B – 1	3,00	76,2	45,72	48,26	29,24	70,5	63,5	–	98,5	124,0	20,61	560 000	24,50	x			x
56 B – 1	3,50	88,9	53,34	53,98	34,32	81,3	77,0	–	114,7	140,0	27,9	850 000	36,50	x			x
○ 64 B – 1	4,00	101,6	60,96	63,50	39,40	92,0	93,3	–	130,0	143,0	36,25	1 120 000	50,0	x			
○ 72 B – 1	4,50	114,3	68,58	72,39	44,50	103,8	105,3	–	147,0	161,0	46,19	1 400 000	65,0	x			

*) On request, we shall advise the effective higher Rexnord breaking load values and fatigue resistance values.

Roller Chains, Double Strand, DIN 8187 / ISO 606

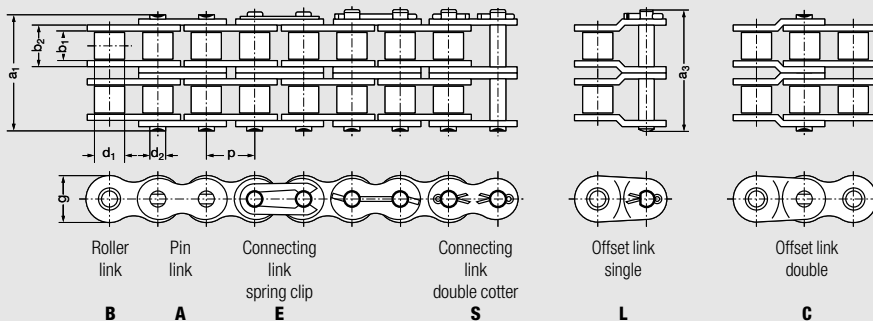

ISO-No.	Pitch p		Roller Width b ₁ min. mm	Roller Diameter d ₁ max. mm	Pin Diameter d ₂ max. mm	Inner Width b ₂ max. mm	Linkplate Height g max. mm	Transverse e mm	Pin Width a ₁ max. mm	Overall Width a ₃ max. mm	Bearing Area A cm ²	Required *) Ultimate Strength min. F _B N	Weight ≈ q kg/m	Loose Parts			
	inch	mm												S	C	E	L
	■ 06 B - 2	0,375	9,525	5,72	6,35	3,28	8,53	8,2	10,24	23,8	27,1	0,56	16 900	0,78		x	x
■ 08 B - 2	0,50	12,7	7,75	8,51	4,45	11,3	11,6	13,92	31,0	33,0	1,01	32 000	1,40		x	x	x
■ 10 B - 2	0,625	15,875	9,65	10,16	5,08	13,28	14,6	16,59	36,2	38,6	1,34	44 500	1,80		x	x	x
■ 12 B - 2	0,75	19,05	11,68	12,07	5,72	15,62	15,9	19,46	42,2	44,4	1,79	57 800	2,30		x	x	x
■ 16 B - 2	1,00	25,4	17,02	15,88	8,28	25,4	20,5	31,88	68,0	74,0	4,21	106 000	5,30	x	x	x	x
■ 20 B - 2	1,25	31,75	19,56	19,05	10,19	29,0	25,7	36,45	76,9	83,6	5,91	170 000	7,25	x			x
■ 24 B - 2	1,50	38,1	25,4	25,4	14,63	37,9	33,0	48,36	102,2	112,7	11,09	280 000	13,75	x			x
■ 28 B - 2	1,75	44,45	30,99	27,94	15,90	46,5	37,0	59,56	122,8	132,7	14,79	360 000	17,30	x			x
■ 32 B - 2	2,00	50,8	30,8	29,21	17,81	45,5	41,2	58,55	123,6	132,4	16,21	450 000	18,80	x			x
■ 40 B - 2	2,50	63,5	38,1	39,37	22,89	55,7	51,5	72,29	151,2	163,8	25,5	630 000	29,90	x			x
■ 48 B - 2	3,00	76,2	45,72	48,26	29,24	70,5	63,5	91,21	189,7	215,2	41,23	1 000 000	48,60	x			x
■ 56 B - 2	3,50	88,9	53,34	53,98	34,32	81,3	77,0	106,6	221,3	246,5	55,8	1 600 000	72,50	x			x
○ 64 B - 2	4,00	101,6	60,96	63,50	39,40	92,0	93,3	119,89	250,0	263,0	72,5	2 000 000	98,0	x			
○ 72 B - 2	4,50	114,3	68,58	72,39	44,50	103,8	105,3	136,27	283,0	297,0	92,4	2 500 000	128,0	x			

Roller Chains, Triple Strand, DIN 8187 / ISO 606

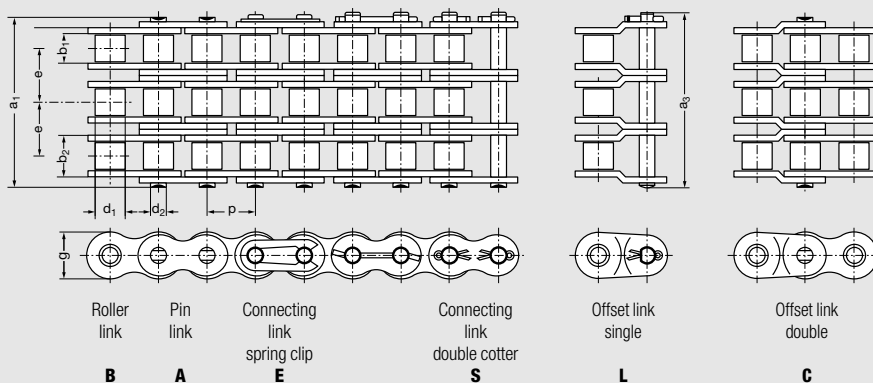

ISO-No.	Pitch p		Roller Width b ₁ min. mm	Roller Diameter d ₁ max. mm	Pin Diameter d ₂ max. mm	Inner Width b ₂ max. mm	Linkplate Height g max. mm	Transverse e mm	Pin Width a ₁ max. mm	Overall Width a ₃ max. mm	Bearing Area A cm ²	Required *) Ultimate Strength min. F _B N	Weight ≈ q kg/m	Loose Parts			
	inch	mm												S	C	E	L
	■ 06 B - 3	0,375	9,525	5,72	6,35	3,28	8,53	8,3	10,24	34,0	37,3	0,84	24 900	1,18		x	x
■ 08 B - 3	0,50	12,7	7,75	8,51	4,45	11,3	11,6	13,92	44,9	47,2	1,51	47 500	2,10		x	x	x
■ 10 B - 3	0,625	15,875	9,65	10,16	5,08	13,28	14,6	16,59	52,8	55,6	2,02	66 700	2,60		x	x	x
■ 12 B - 3	0,75	19,05	11,68	12,07	5,72	15,62	15,9	19,46	61,7	65,2	2,68	86 700	3,40		x	x	x
■ 16 B - 3	1,00	25,4	17,02	15,88	8,28	25,4	20,5	31,88	99,9	107,2	6,31	160 000	7,80		x	x	x
■ 20 B - 3	1,25	31,75	19,56	19,05	10,19	29,0	25,7	36,45	113,4	121,2	8,87	250 000	10,85	x			x
■ 24 B - 3	1,50	38,1	25,4	25,4	14,63	37,9	33,0	48,36	150,5	160,4	16,63	425 000	20,50	x			x
■ 28 B - 3	1,75	44,45	30,99	27,94	15,90	46,5	37,0	59,56	182,3	192,2	22,18	530 000	25,75	x			x
■ 32 B - 3	2,00	50,8	30,8	29,21	17,81	45,5	41,2	58,55	182,2	191,0	24,31	670 000	27,95	x			x
■ 40 B - 3	2,50	63,5	38,1	39,37	22,89	55,7	51,5	72,29	223,5	236,1	38,25	950 000	44,80	x			x
■ 48 B - 3	3,00	76,2	45,72	48,26	29,24	70,5	63,5	91,21	281,0	306,5	61,84	1 500 000	72,50	x			x
■ 56 B - 3	3,50	88,9	53,34	53,98	34,32	81,3	77,0	106,6	328,0	353,2	83,71	2 240 000	109,00	x			x

64 B - 3 and 72 B - 3 on request.

*) On request, we shall advise the effective higher Rexnord breaking load values and fatigue resistance values.

Roller Chains American Standard



*Optimum Constructive
and Technical Coordination of
the Individual Chain Parts*

Attention:

ANSI 140 – ANSI 240 roller chains and the Heavy series chains 60 H – 200 H see next pages.

Please mind the different design of connecting links and cotter versions for the ANSI 140 – ANSI 240 chains compared with chains on this page.

Available upon request: Our Oilfield Roller Chain Catalogue with 4 to 8 strand roller chains ANSI.

Links A and B available for all chains.

- Bushed chain.
- With straight link plates on page 21.
- 1) Bushing diameter available up to and incl. ANSI 50 rivet only, from ANSI 60 upwards riveted and cottered.

Roller Chains, Single Strand, DIN 8188/ANSI

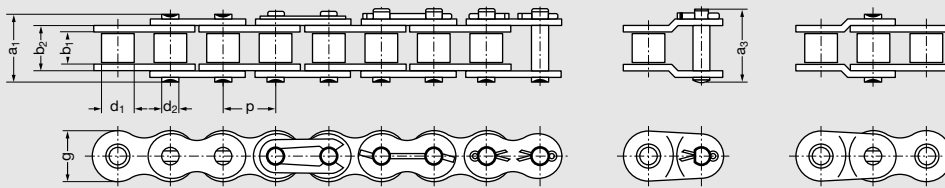

Roller link **B** Pin link **A** Connecting link spring clip **E** Connecting link double cotter **S** Offset link single **L** Offset link double **C**

ANSI- No.	Pitch p		Roller Width	Roller Diameter	Pin Diameter	Inner Width	Linkplate Height	Trans- verse	Pin Width	Overall Width	Bearing Area	Required *) Ultimate Strength min. F _B N	Weight	Loose Parts			
	inch	mm	b ₁ min. mm	d ₁ max. mm	d ₂ max. mm	b ₂ max. mm	g max. mm	e mm	a ₁ max. mm	a ₃ max. mm	A cm ²	≈ q kg/m	S	C	E	L	
● 35	0,375	9,525	4,68	5,08 ¹⁾	3,58	7,47	9,0	–	12,0	14,4	0,27	7 900	0,33		x	x	x
40	0,50	12,7	7,85	7,95	3,96	11,15	11,6	–	16,3	19,1	0,44	14 100	0,62		x	x	x
50	0,625	15,875	9,4	10,16	5,08	13,8	14,6	–	20,3	23,0	0,70	22 200	1,01		x	x	x
■ 60	0,75	19,05	12,57	11,91	5,94	17,7	17,7	–	25,7	28,6	1,05	31 800	1,48	x	x	x	x
80	1,00	25,4	15,75	15,88	7,92	22,5	23,5	–	33,0	38,0	1,78	56 700	2,60	x	x	x	x
100	1,25	31,75	18,9	19,05	9,53	27,4	29,2	–	39,4	44,9	2,61	88 500	3,76	x			x
120	1,50	38,1	25,22	22,23	11,1	35,3	34,4	–	49,8	56,1	3,92	127 000	5,50	x			x

*) On request, we shall advise the effective higher Rexnord breaking load values and fatigue resistance values.

Roller Chains, Double Strand, DIN 8188/ANSI

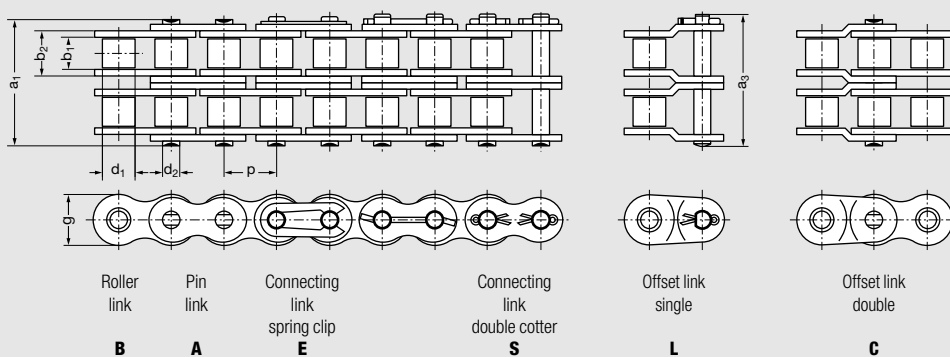

ANSI- No.	Pitch p		Roller Width b ₁ min. mm	Roller Diameter d ₁ max. mm	Pin Diameter d ₂ max. mm	Inner Width b ₂ max. mm	Linkplate Height g max. mm	Trans- verse e mm	Pin Width a ₁ max. mm	Overall Width a ₃ max. mm	Bearing Area A cm ²	Required *) Ultimate Strength min. F _B N	Weight ≈ q kg/m	Loose Parts			
	inch	mm												S	C	E	L
● 35-2	0,375	9,525	4,68	5,08 1)	3,58	7,47	8,3	10,13	22,1	24,5	0,53	15 800	0,65		x	x	x
40-2	0,50	12,7	7,85	7,95	3,96	11,15	11,6	14,38	30,7	33,5	0,88	28 200	1,22			x	x
50-2	0,625	15,875	9,4	10,16	5,08	13,8	14,6	18,11	38,5	41,3	1,40	44 400	2,00		x	x	x
60-2	0,75	19,05	12,57	11,91	5,94	17,7	17,7	22,78	48,5	51,5	2,10	63 600	2,95	x		x	x
80-2	1,00	25,4	15,75	15,88	7,92	22,5	23,5	29,29	62,4	67,1	3,56	113 400	5,20	x			x
100-2	1,25	31,75	18,9	19,05	9,53	27,4	29,2	35,76	75,3	87,8	5,22	177 000	7,60	x			x
120-2	1,50	38,1	25,22	22,23	11,1	35,3	34,4	45,44	95,3	101,6	7,84	254 000	10,80	x			x

Roller Chains, Triple Strand, DIN 8188/ANSI

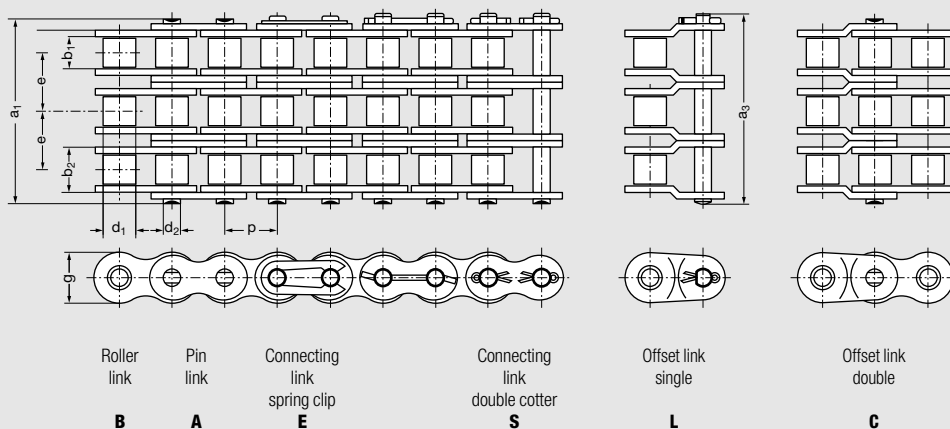

ANSI- No.	Pitch p		Roller Width b ₁ min. mm	Roller Diameter d ₁ max. mm	Pin Diameter d ₂ max. mm	Inner Width b ₂ max. mm	Linkplate Height g max. mm	Trans- verse e mm	Pin Width a ₁ max. mm	Overall Width a ₃ max. mm	Bearing Area A cm ²	Required *) Ultimate Strength min. F _B N	Weight ≈ q kg/m	Loose Parts			
	inch	mm												S	C	E	L
● 35-3	0,375	9,525	4,68	5,08 1)	3,58	7,47	8,3	10,13	32,3	34,7	0,80	23 700	0,97		x	x	x
40-3	0,50	12,7	7,85	7,95	3,96	11,15	11,6	14,48	45,1	48,0	1,32	42 300	1,83			x	x
50-3	0,625	15,875	9,4	10,16	5,08	13,8	14,6	18,11	56,7	59,8	2,10	66 600	2,97			x	x
60-3	0,75	19,05	12,57	11,91	5,94	17,7	17,7	22,78	71,4	75,6	3,15	95 400	4,35	x		x	x
80-3	1,00	25,4	15,75	15,88	7,92	22,5	23,5	29,29	91,7	97,7	5,35	170 100	7,90	x			x
100-3	1,25	31,75	18,9	19,05	9,53	27,4	29,2	35,76	111,1	117,2	7,83	265 500	11,40	x			x
120-3	1,50	38,1	25,22	22,23	11,1	35,3	34,4	45,44	140,7	148,3	11,76	381 000	15,80	x			x

*) On request, we shall advise the effective higher Rexnord breaking load values and fatigue resistance values.

Roller Chains American Standard



*Large Pitch Roller Chains
for high demands*

Links A and B available for all chains.

Roller Chains, Single Strand, DIN 8188/ANSI

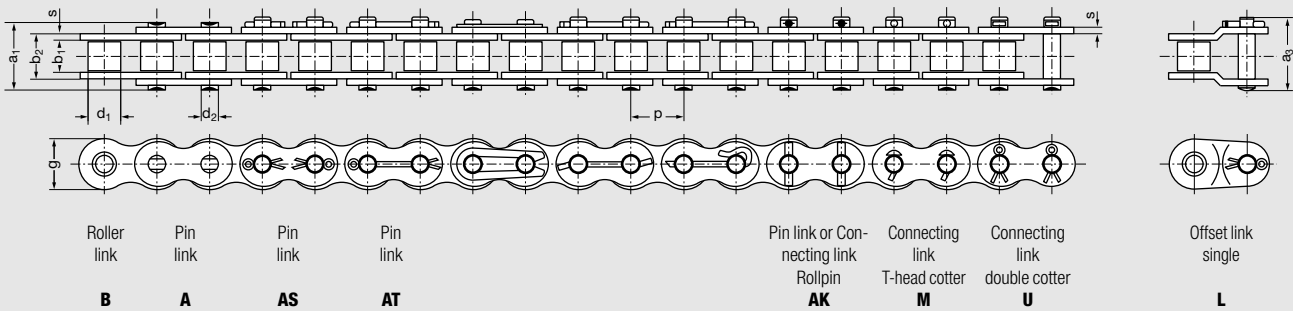

ANSI- No.	Pitch p		Roller Width b_1 min. mm	Roller Diameter d_1 max. mm	Pin Diameter d_2 max. mm	Inner Width b_2 max. mm	Linkplate Height g max. mm	Trans- verse e mm	Pin Width a_1 max. mm	Overall Width a_3 max. mm	Bearing Area A cm ²	Required *) Ultimate Strength min. F_B N	Weight $\approx q$ kg/m	Outer Link Stand.	Loose Parts	
	inch	mm												Type	U	L
140	1,75	44,45	25,22	25,4	12,7	37,0	40,8	–	53,4	59,3	4,7	172 400	7,2	AT	x	x
160	2,00	50,8	31,55	28,58	14,27	45,0	47,8	–	63,6	68,9	6,42	226 800	10,3	AT	x	x
180	2,25	57,15	35,48	35,71	17,46	50,85	50	–	71,3	80,0	8,87	280 200	14,0	AT	x	x
200	2,50	63,5	37,85	39,68	19,84	54,7	60	–	78,0	87,5	10,85	353 800	16,8	AT	x	x
240	3,00	76,2	47,35	47,63	23,8	67,5	70	–	94,8	106,7	16,07	510 300	25,0	AS	x	x

*) Breaking load is only a static value. Since almost every drive will be dynamically loaded, on request, we shall advise the effective higher Rexnord breaking load values as well as our effective fatigue resistance values.

Roller Chains, Double Strand, DIN 8188/ANSI

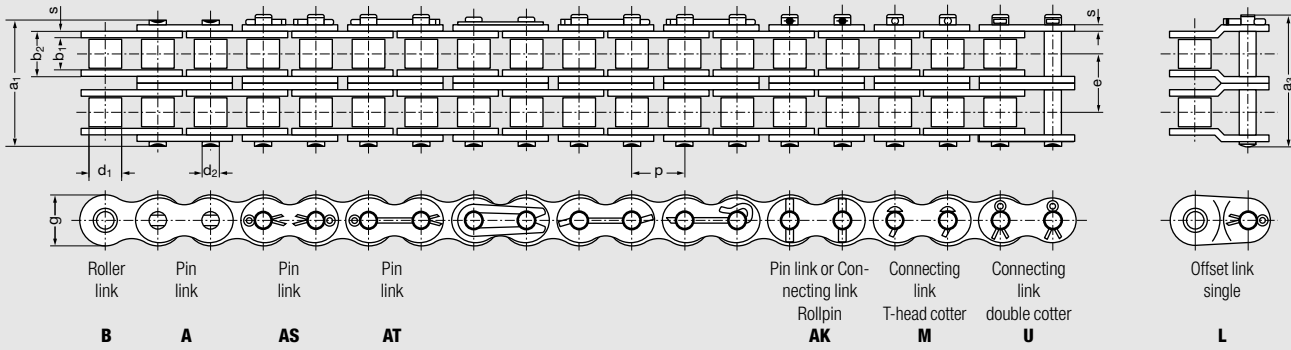

ANSI- No.	Pitch p		Roller Width b_1 min. mm	Roller Diameter d_1 max. mm	Pin Diameter d_2 max. mm	Inner Width b_2 max. mm	Linkplate Height g max. mm	Trans- verse e mm	Pin Width a_1 max. mm	Overall Width a_3 max. mm	Bearing Area A cm ²	Required *) Ultimate Strength min. F_B N	Weight $\approx q$ kg/m	Outer Link Stand.		Loose Parts	
	inch	mm												Type	U	L	
140-2	1,75	44,45	25,22	25,4	12,7	37,0	40,8	48,87	103,3	109,6	9,4	344 800	14,2	AK	x	x	
160-2	2,00	50,8	31,55	28,58	14,27	45,0	47,8	58,55	122,1	130,1	12,84	453 600	19,5	AK	x	x	
180-2	2,25	57,15	35,48	35,71	17,46	50,85	50	65,84	136,7	145,4	17,74	560 500	27,0	AK	x	x	
200-2	2,50	63,5	37,85	39,68	19,84	54,7	60	71,55	149,6	159,2	21,7	707 600	32,7	AT	x	x	
240-2	3,00	76,2	47,35	47,63	23,8	67,5	70	87,83	182,7	194,7	32,13	1 020 600	49,4	AS	x	x	

Roller Chains, Triple Strand, DIN 8188/ANSI

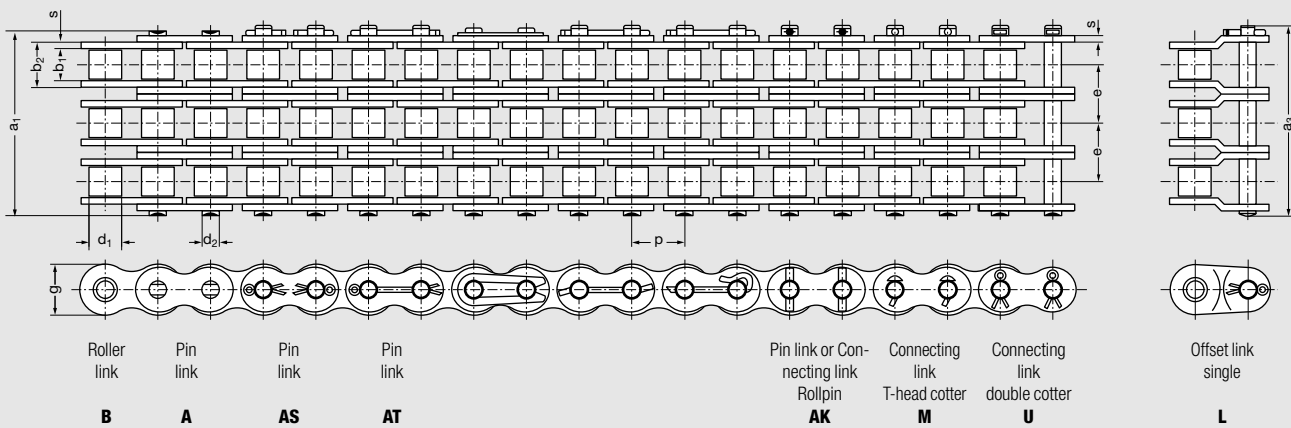

ANSI- No.	Pitch p		Roller Width b_1 min. mm	Roller Diameter d_1 max. mm	Pin Diameter d_2 max. mm	Inner Width b_2 max. mm	Linkplate Height g max. mm	Trans- verse e mm	Pin Width a_1 max. mm	Overall Width a_3 max. mm	Bearing Area A cm ²	Required *) Ultimate Strength min. F_B N	Weight $\approx q$ kg/m	Outer Link Stand.		Loose Parts	
	inch	mm												Type	U	L	
140-3	1,75	44,45	25,22	25,4	12,7	37,0	40,8	48,87	151,2	158,5	14,1	517 200	21,5	AK	x	x	
160-3	2,00	50,8	31,55	28,58	14,27	45,0	47,8	58,55	180,7	188,7	19,26	680 400	26,3	AK	x	x	
180-3	2,25	57,15	35,48	35,71	17,46	50,85	50	65,84	202	210,7	26,61	840 700	40,5	AK	x	x	
200-3	2,50	63,5	37,85	39,68	19,84	54,7	60	71,55	221,1	230,7	32,56	1 061 400	48,8	AT	x	x	
240-3	3,00	76,2	47,35	47,63	23,8	67,5	70	87,83	270,6	282,5	48,2	1 530 900	74,1	AS	x	x	

*) On request, we shall advise the effective higher Rexnord breaking load values and fatigue resistance values.

Roller Chains

American Standard, H-Series



*Small Alterations -
High Fatigue Strength*

Links A and B available for all chains.

Advantages of Rexnord "H"-Chains

The pins for Rexnord roller chains of the heavy series – as well as the roller chains American standard – are made from high quality case hardened steel.

For both the surface hardness of approx. 60HRc guarantees the excellent Rexnord wear resistance. The link plates however are thicker. They are taken from the next larger chain (see page 42).

The fatigue strength is increased by 40 % for Rexnord chains of the heavy series. This is also valid for the allowable loading.

The statement that there is no difference in breaking force between American standard and heavy series will not effect the above mentioned 40 % higher allowable loading.

It is the cross section of the link plates which determines the fatigue strength and also the allowable loading.

The pins of the ANSI-series are not critical in respect to fatigue strength, they only limit the breaking force.

Breaking force however is not valid for dynamic load. It is only significant with static load and to investigate so called security factors.

Roller Chains, Single Strand, ANSI Heavy Series with Higher Fatigue Resistance (Thicker Link Plates)

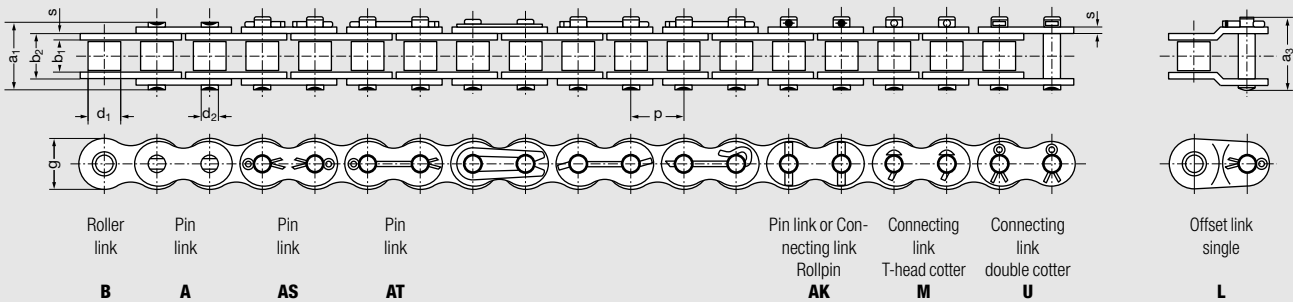

ANSI- No.	Pitch p		Roller Width b ₁ min. mm	Roller Diameter d ₁ max. mm	Pin Diameter d ₂ max. mm	Inner Width b ₂ max. mm	Plate Thickness s mm	Linkplate Height g max. mm	Trans- verse e mm	Pin Width a ₁ max. mm	Overall Width a ₃ max. mm	Bearing Area A cm ²	Required*) Ultimate Strength min. F _B N	Weight ≈ q kg/m	Outer Link Stand.			Loose Parts		
	inch	mm													Type	S	U	L		
60 H	0,75	19,05	12,57	11,91	5,94	19,35	3,05	17,7	–	28,8	32,0	1,15	31 800	1,97		x		x		
80 H	1,00	25,4	15,75	15,88	7,92	24,3	4,0	23,5	–	35,9	41,0	1,94	56 700	3,2		x		x		
100 H	1,25	31,75	18,9	19,05	9,53	29,0	4,7	29,2	–	42,8	48,2	2,76	88 500	4,4		x		x		
120 H	1,50	38,1	25,22	22,23	11,1	37,0	5,5	34,4	–	53,0	59,0	4,12	127 000	6,4		x		x		
140 H	1,75	44,45	25,22	25,4	12,7	38,7	6,3	40,8	–	56,6	62,6	4,91	172 400	8,3		AT	x	x	x	
160 H	2,00	50,8	31,55	28,58	14,27	46,9	7,0	47,8	–	67,2	72,3	6,69	226 800	11,5		AT	x	x	x	
200 H	2,50	63,5	37,85	39,68	19,84	57,6	9,5	60,0	–	84,0	93,5	11,42	353 800	20,0		AT	x	x	x	

*) On request, we shall advise the effective higher Rexnord breaking load values and fatigue resistance values.

Roller Chains, Double Strand, ANSI Heavy Series with Higher Fatigue Resistance (Thicker Link Plates)

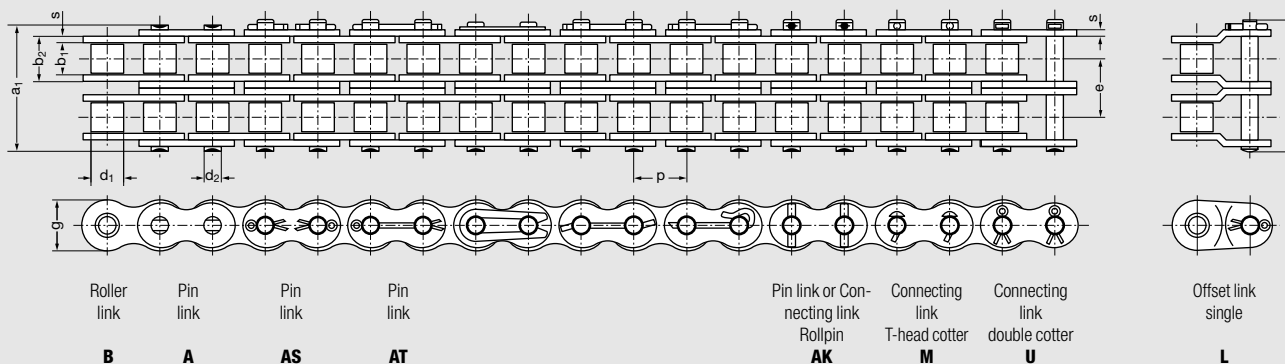

ANSI- No.	Pitch p		Roller Width b ₁ min. mm	Roller Diameter d ₁ max. mm	Pin Diameter d ₂ max. mm	Inner Width b ₂ max. mm	Plate Thickness s mm	Linkplate Height g max. mm	Trans- verse e mm	Pin Width a ₁ max. mm	Overall Width a ₃ max. mm	Bearing Area A cm ²	Required*) Ultimate Strength min. F _B N	Weight ≈ q kg/m	Outer Link Stand.		Loose Parts		
	inch	mm													Type	S	U	L	
60 H - 2	0,75	19,05	12,57	11,91	5,94	19,35	3,05	17,7	26,1	54,9	58,0	2,3	63 600	3,95		x		x	
80 H - 2	1,00	25,4	15,75	15,88	7,92	24,3	4,0	23,5	32,6	68,6	73,7	3,88	113 400	6,3		x		x	
100 H - 2	1,25	31,75	18,9	19,05	9,53	29,0	4,7	29,2	39,12	82,0	97,8	5,52	177 000	9,0		x		x	
120 H - 2	1,50	38,1	25,22	22,23	11,1	37,0	5,5	34,4	48,91	101,8	109,5	8,36	254 000	12,6		x		x	
140 H - 2	1,75	44,45	25,22	25,4	12,7	38,7	6,3	40,8	52,2	108,7	116,0	9,82	344 800	16,2	AK	x	x	x	
160 H - 2	2,00	50,8	31,55	28,58	14,27	46,9	7,0	47,8	61,89	128,6	136,8	13,4	453 600	22,0	AK	x	x	x	
200 H - 2	2,50	63,5	37,85	39,68	19,84	57,6	9,5	60,0	78,3	161,6	171,2	22,84	707 600	39,0	AT	x	x	x	

Roller Chains, Triple Strand, ANSI Heavy Series with Higher Fatigue Resistance (Thicker Link Plates)

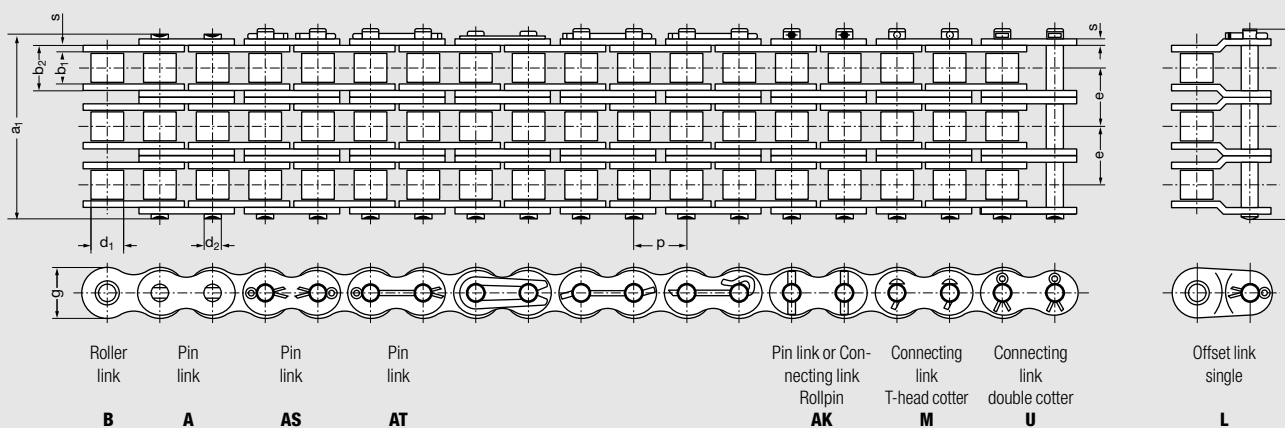

ANSI- No.	Pitch p		Roller Width b ₁ min. mm	Roller Diameter d ₁ max. mm	Pin Diameter d ₂ max. mm	Inner Width b ₂ max. mm	Plate Thickness s mm	Linkplate Height g max. mm	Trans- verse e mm	Pin Width a ₁ max. mm	Overall Width a ₃ max. mm	Bearing Area A cm ²	Required*) Ultimate Strength min. F _B N	Weight ≈ q kg/m	Outer Link Stand.		Loose Parts		
	inch	mm													Type	S	U	L	
60 H - 3	0,75	19,05	12,57	11,91	5,94	19,35	3,05	17,7	26,1	81,1	84,4	3,45	95 400	5,8		x		x	
80 H - 3	1,00	25,4	15,75	15,88	7,92	24,3	4,0	23,5	32,6	101,2	106,3	5,82	170 100	9,6		x		x	
100 H - 3	1,25	31,75	18,9	19,05	9,53	29,0	4,7	29,2	39,12	120,0	126,6	8,3	265 500	13,4		x		x	
120 H - 3	1,50	38,1	25,22	22,23	11,1	37,0	5,5	34,4	48,91	150,8	158,7	12,35	381 000	19,5		x		x	
140 H - 3	1,75	44,45	25,22	25,4	12,7	38,7	6,3	40,8	52,2	160,9	168,3	14,3	517 200	24,7	AK	x	x	x	
160 H - 3	2,00	50,8	31,55	28,58	14,27	46,9	7,0	47,8	61,89	198,0	198,7	20,1	680 400	29,4	AK	x	x	x	
200 H - 3	2,50	63,5	37,85	39,68	19,84	57,6	9,5	60,0	78,3	239,1	248,7	34,26	1 061 400	58,0	AT	x	x	x	

*) On request, we shall advise the effective higher Rexnord breaking load values and fatigue resistance values.

Roller Chains, American Standard, HE-Series



*Extremely High
Shock Resistance*

Links A and B available for all chains.

Advantages of Rexnord "HE"-Chains

We use for the Rexnord roller chains of the HE-series link plates of the next larger chain that means compared with the standard series an increase of 40 % for fatigue resistance. For heavy series with HE-series we use pins made from through hardened material. Its higher shear and yield strength increase the breaking force and the shock resistance.

Pins made from through hardened material have not the same high surface hardness as case hardened pins from the standard or "H"-series. That means a slightly lower wear resistance.

In case high resistance strength is important and sufficient lubrication cannot be guaranteed and additional inductive surface hardening for the pins should be considered. Thus will increase the surface

hardness above 60 HRC and besides the already existing high fatigue strength and shock resistance an extremely high wear resistance will be yielded.

Thickness of link plates are nominal sizes. On request we will state exact dimensions and tolerances.

Roller Chains, Single Strand, ANSI, Heavy Series with Higher Fatigue Resistance (Thicker Link Plates and Higher Breaking Force)

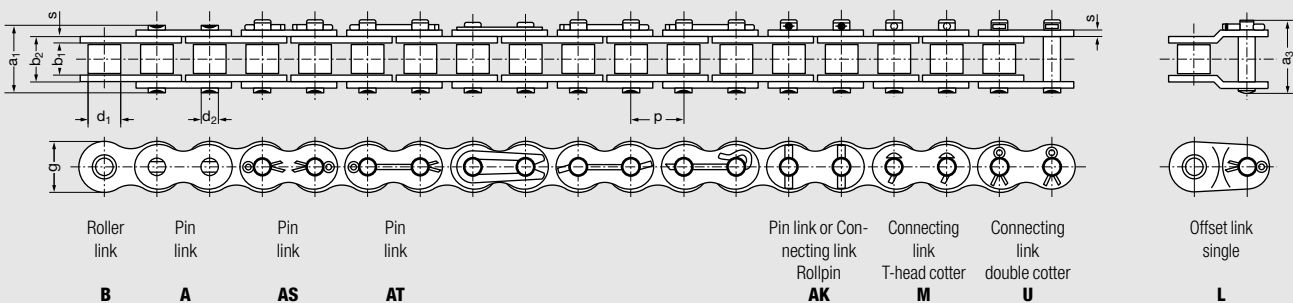

ANSI- No.	Pitch p		Roller Width b ₁ min. mm	Roller Diameter d ₁ max. mm	Pin Diameter d ₂ max. mm	Inner Width b ₂ max. mm	Plate Thickness s mm	Linkplate Height g max. mm	Trans- verse e mm	Pin Width a ₁ max. mm	Overall Width a ₃ max. mm	Bearing Area A cm ²	Required*) Ultimate Strength min. F _B N	Weight ≈ q kg/m	Outer Link Stand.			Loose Parts			
	inch	mm													Type	S	U	L			
60 HE	0,75	19,05	12,57	11,91	5,94	19,35	3,05	17,7	–	28,8	32,0	1,15	42 000	1,97		x		x			
80 HE	1,00	25,4	15,75	15,88	7,92	24,3	4,0	23,3	–	35,9	41,0	1,94	75 600	3,2		x		x			
100 HE	1,25	31,75	18,9	19,05	9,53	29,0	4,7	29,2	–	42,8	48,2	2,76	113 400	4,4		x		x			
120 HE	1,50	38,1	25,22	22,23	11,1	37,0	5,5	34,4	–	53,0	59,0	4,1	155 700	6,4		x		x			
140 HE	1,75	44,45	25,22	25,4	12,7	38,7	6,3	40,8	–	56,6	62,6	4,94	209 100	8,3		AT	x	x	x		
160 HE	2,00	50,8	31,55	28,58	14,27	46,9	7,0	47,8	–	67,2	72,3	6,69	266 900	11,8		AT	x	x	x		
200 HE	2,50	63,5	37,85	39,68	19,84	57,6	9,5	60,0	–	84,0	93,5	11,42	405 000	20,0		AT	x	x	x		

*) On request, we shall advise the effective higher Rexnord breaking load values and fatigue resistance values.

Roller Chains, Double Strand, ANSI, Heavy Series with Higher Fatigue Resistance (Thicker Link Plates and Higher Breaking Force)

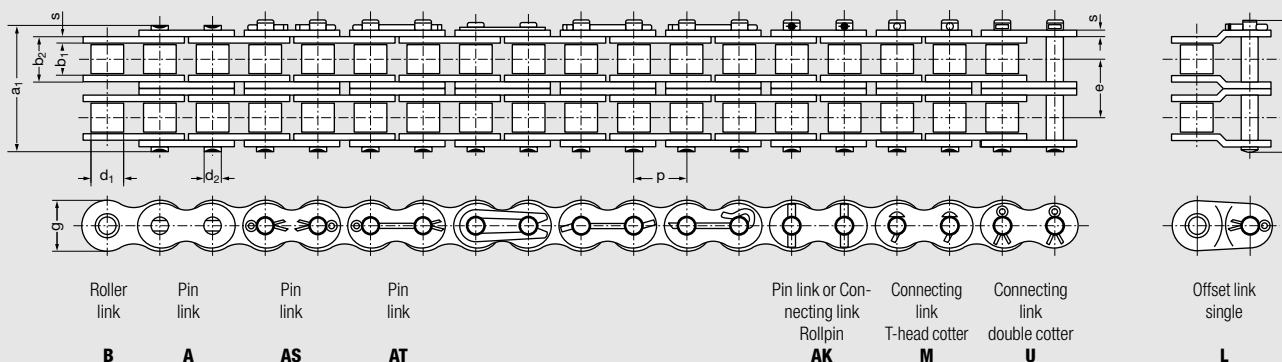

ANSI- No.	Pitch p		Roller Width b ₁ min. mm	Roller Diameter d ₁ max. mm	Pin Diameter d ₂ max. mm	Inner Width b ₂ max. mm	Plate Thickness s mm	Linkplate Height g max. mm	Trans- verse e mm	Pin Width a ₁ max. mm	Overall Width a ₃ max. mm	Bearing Area A cm ²	Required*) Ultimate Strength min. F _B N	Weight ≈ q kg/m	Outer Link Stand.			Loose Parts		
	inch	mm													Type	S	U	L		
80 HE - 2	1,00	25,4	15,75	15,88	7,92	24,3	4,0	23,5	32,6	68,6	73,7	3,88	151 200	5,3		x		x		
100 HE - 2	1,25	31,75	18,9	19,05	9,53	29,0	4,7	29,2	39,12	82,0	87,8	5,52	226 800	9,0		x		x		
120 HE - 2	1,50	38,1	25,22	22,23	11,1	37,0	5,5	34,4	48,91	101,8	109,5	8,36	311 400	12,6		x		x		
140 HE - 2	1,75	44,45	25,22	25,4	12,7	38,7	6,3	40,8	52,2	108,7	116,0	9,82	418 200	15,8	AK	x	x	x		
160 HE - 2	2,00	50,8	31,55	28,58	14,27	46,9	7,0	47,8	61,89	128,6	136,8	13,4	533 800	22,0	AK	x	x	x		
200 HE - 2	2,50	63,5	37,85	39,68	19,84	57,6	9,5	60,0	78,3	161,6	171,2	22,84	810 000	39,0	AT	x	x	x		

Roller Chains, Triple Strand, ANSI, Heavy Series with Higher Fatigue Resistance (Thicker Link Plates and Higher Breaking Force)

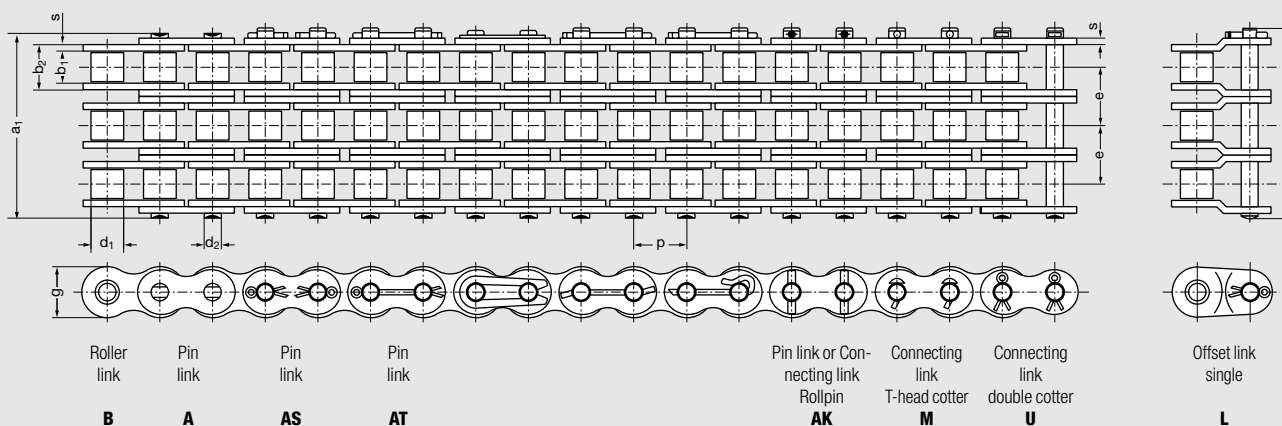

ANSI- No.	Pitch p		Roller Width b ₁ min. mm	Roller Diameter d ₁ max. mm	Pin Diameter d ₂ max. mm	Inner Width b ₂ max. mm	Plate Thickness s mm	Linkplate Height g max. mm	Trans- verse e mm	Pin Width a ₁ max. mm	Overall Width a ₃ max. mm	Bearing Area A cm ²	Required*) Ultimate Strength min. F _B N	Weight ≈ q kg/m	Outer Link Stand.			Loose Parts		
	inch	mm													Type	S	U	L		
80 HE - 3	1,00	25,4	15,75	15,88	7,92	24,3	4,0	23,5	32,6	101,2	106,3	5,82	226 800	9,6		x		x		
100 HE - 3	1,25	31,75	18,9	19,05	9,53	29,0	4,7	29,2	39,12	120,0	126,6	8,3	340 200	13,4		x		x		
120 HE - 3	1,50	38,1	25,22	22,23	11,1	37,0	5,5	34,4	48,91	150,8	158,7	12,35	467 100	18,5		x		x		
140 HE - 3	1,75	44,45	25,22	25,4	12,7	38,7	6,3	40,8	52,2	160,9	168,3	14,3	627 300	24,7	AK	x	x	x		
160 HE - 3	2,00	50,8	31,55	28,58	14,27	46,9	7,0	47,8	61,89	198,0	198,7	20,1	800 700	29,4	AK	x	x	x		
200 HE - 3	2,50	63,5	37,85	39,68	19,84	57,6	9,5	60,0	78,3	239,1	248,7	34,26	1215 000	58,0	AT	x	x	x		

*) On request, we shall advise the effective higher Rexnord breaking load values and fatigue resistance values.

Roller Chains, Industry Standard



*Industry Standard Chains -
For Individual Demands*

Links A and B available for all chains.

All roller chains with straight side plates can be supplied in multiple strand execution.

- 1) Bushing diameter.
He 488 = Bushed chain.
- Higher inner plate "g" = higher fatigue strength

Roller Chains, Industry Standard

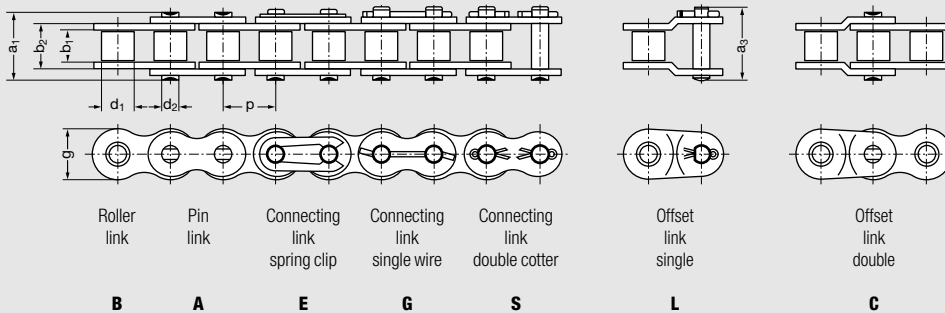

Chain No.	Pitch p		Roller Width b ₁ min. mm	Roller Diameter d ₁ max. mm	Pin Diameter d ₂ max. mm	Inner Width b ₂ max. mm	Linkplate Height g max. mm	Transverse e mm	Pin Width a ₁ max. mm	Overall Width a ₃ max. mm	Bearing Area A cm ²	Required *) Ultimate Strength min. F _B N	Weight ≈ q kg/m	Loose Parts			
	inch	mm												S	C	E	L
Re 217	0,50	12,7	6,4	8,51	4,45	9,93	11,6	—	15,4	18,9	0,44	18 000	0,67		x	x	x
Re 317	0,625	15,875	6,48	10,16	5,08	10,08	14,7	—	16,0	20,0	0,51	23 600	0,80		x	x	x
Re 425	0,75	19,05	13,5	12,07	5,72	19,4	16,8	—	27,0	31,8	1,12	33 500	1,57	x	x	x	x
Re 480	0,75	19,05	11,68	12,07	6,10	17,23	16,8	—	25,0	29,5	1,05	40 000	1,45	G	x	x	x
Re 487	0,787	20,0	16,0	12,0	6,0	22,5	19,0	—	32,1	35,9	1,35	35 500	2,00	x	G	x	x
He 488	0,787	20,0	16,0	12,0 ¹⁾	8,0	22,5	19,0	—	32,5	37,3	1,80	35 500	2,00	x	x	x	x
Re 514	1,00	25,4	12,7	14,0	7,0	19,07	19,7	—	27,3	33,1	1,33	45 000	1,74	x	x	x	x
Re 516	1,00	25,4	12,7 ¹⁾	15,88	8,28	21,07	20,6	—	30,8	37,6	1,74	63 000	2,4	x	x	x	x
Re 519	1,00	25,4	17,02	15,88	9,0	25,4	24,1	—	36,0	39,8	2,29	80 000	3,16	x	x	G	
Rz 519	1,00	25,4	17,02	15,88	9,0	25,4	24,1	31,88	67,8	72,0	4,58	160 000	6,25	x	x	G	
Re 525	1,00	25,4	12,7	12,7	7,0	19,07	20,8	—	27,4	32,5	1,33	45 000	1,59	x	x	x	x
Re 626	1,18	30,0	17,02	15,88	8,28	25,4	20,5	—	35,5	41,9	2,10	63 000	2,33	x	x		x

*) On request, we shall advise the effective higher Rexnord breaking load values and fatigue resistance values.

Roller Chains without Rollers for Lifting Applications and Rock Drilling Machinery

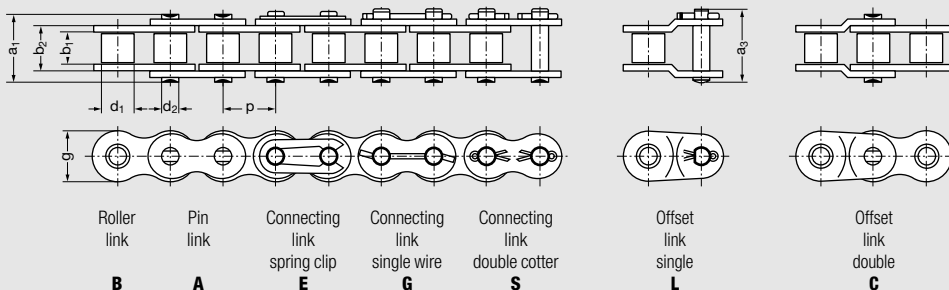

Chain No.	Pitch p		Roller Width b ₁ min. mm	Roller Diameter d ₁ max. mm	Pin Diameter d ₂ max. mm	Inner Width b ₂ max. mm	Linkplate Height g max. mm	Pin Width a ₁ max. mm	Overall Width a ₃ max. mm	Bearing Area A cm ²	Required *) Ultimate Strength min. F _B N	Weight ≈ q kg/m	Loose Parts				
	inch	mm											S	C	E	L	
16 B - 1 OR	1,00	25,4	17,02	11,72 ¹⁾	8,28	25,4	20,5	35,4	42,4	2,10	60 000	2,20	x		x		
65	0,75	19,05	12,57	9,04 ¹⁾	5,94	17,75	17,7	25,7	28,6	1,06	31 800	1,20	x		x		
85	1,00	25,4	15,75	11,69 ¹⁾	7,92	22,61	23,6	33,0	38,0	1,79	56 700	2,18	x				
105	1,25	31,75	18,9	13,86 ¹⁾	9,53	27,46	29,2	39,4	44,9	2,62	88 500	3,18	x				

Roller Chains for Heavy Drives and Lifting Applications

KRV 12	1,00	25,4	12,7	19,05	10,19	25,7	24,0	40,1	–	2,61	117 500	4,40	x				
R 38 SH	1,50	38,1	25,4	25,4	14,63	40,0	37,2	56,7	–	5,85	235 000	7,80	x				
R 44 SH	1,75	44,45	30,99	27,94	15,90	46,5	40,8	66,3	–	7,39	270 000	9,80	x				

Hoisting Chains for Straddle Carriers

○ 64 S - 1	2,50	63,5	38,1	39,38	22,45	57,9	59,5	84,4	93,9	13,2	530 000	16,50	1				
○ 200 HF	2,50	63,5	38,1	39,68	19,8	54,9	59,5	–	85,6	10,9	353 800	17,00	x				

Roller Chains with Straight Link Plates

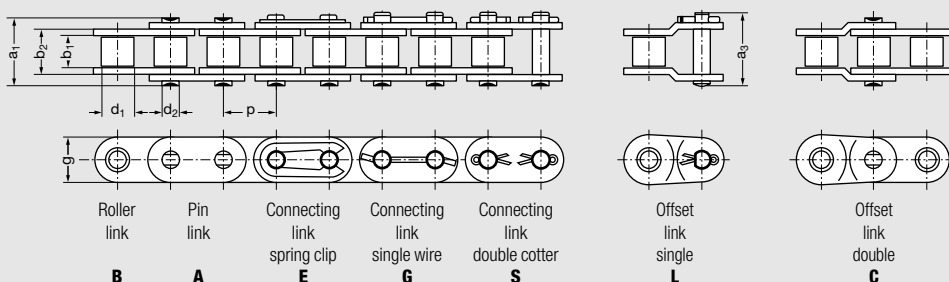

Chain No.	Pitch p		Roller Width b ₁ min. mm	Roller Diameter d ₁ max. mm	Pin Diameter d ₂ max. mm	Inner Width b ₂ max. mm	Linkplate Height g max. mm	Transverse e mm	Pin Width a ₁ max. mm	Overall Width a ₃ max. mm	Bearing Area A cm ²	Required *) Ultimate Strength min. F _B N	Weight ≈ q kg/m	Loose Parts			
	inch	mm												S	C	E	L
○ 06 B - 1 GL	0,375	9,525	5,72	6,35	3,28	8,53	8,1	–	12,8	15,8	0,28	9 000	0,42			x	
○ 06 B - 2 GL	0,375	9,525	5,72	6,35	3,28	8,53	8,1	10,24	23,1	26,0	0,56	16 000	0,78			x	
08 B - 1 GL	0,50	12,7	7,75	8,51	4,45	11,3	12,0	–	17,0	19,0	0,50	18 000	0,75			x	
10 B - 1 GL	0,625	15,875	9,65	10,16	5,08	13,28	13,9	–	18,9	22,0	0,67	22 400	1,0			x	
10 B - 2 GL	0,625	15,875	9,65	10,16	5,08	13,28	13,9	16,59	35,5	38,6	1,34	44 500	1,90			x	
12 B - 1 GL	0,75	19,05	11,68	12,07	5,72	15,62	15,9	–	22,3	25,1	0,89	29 000	1,33			x	
12 B - 2 GL	0,75	19,05	11,68	12,07	5,72	15,62	15,9	19,46	41,7	44,4	1,79	57 800	2,6			x	
16 B - 1 GL	1,00	25,4	17,02	15,88	8,28	25,4	20,3	–	35,4	42,4	2,10	60 000	2,85	x		x	
16 B - 2 GL	1,00	25,4	17,02	15,88	8,28	25,4	20,3	31,88	67,4	74,0	4,21	106 000	5,80	x		x	
20 B - 1 GL	1,25	31,75	19,56	19,05	10,19	29,0	25,8	–	40,4	47,6	2,96	95 000	4,00	x			
24 B - 1 GL	1,50	38,1	25,4	25,4	14,63	37,9	33,0	–	53,8	60,6	5,54	160 000	7,5	x			
32 B - 1 GL	2,00	50,8	30,8	29,21	17,81	45,5	41,2	–	65,1	73,6	8,10	250 000	10,4	x			
60 GL	0,75	19,05	12,57	11,91	5,94	17,7	18,0	–	25,7	29,6	1,05	31 800	1,65			G	x

*) On request, we shall advise the effective higher Rexnord breaking load values and fatigue resistance values.

Roller Chains with Thermoplastic Bearings



Non-Lube Chain

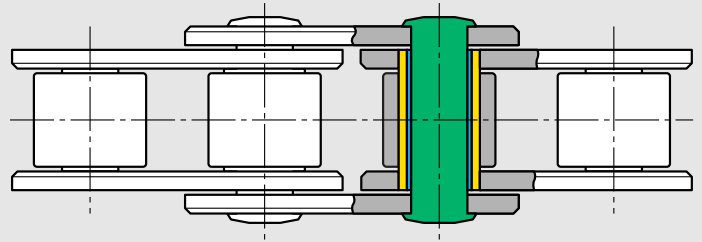

- Bushing
- Pin
- Thermoplastic Bearing

Links A and B available for all chains.

KL Chain length tolerance = 0 – 0,35 %.

Roller Chains, Single Strand, with Thermoplastic Bearings

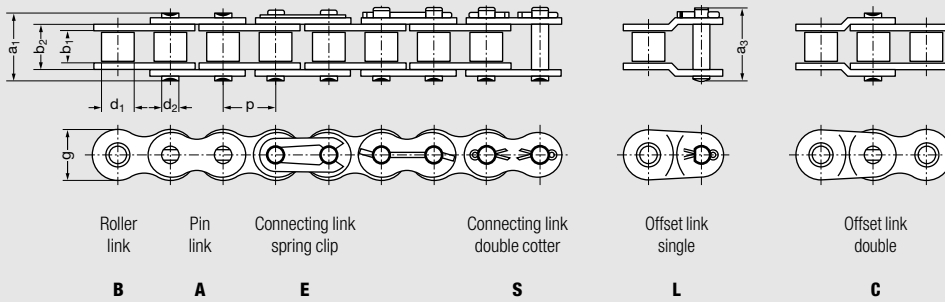

Chain No.	Pitch p		Roller Width b ₁ min. mm	Roller Diameter d ₁ max. mm	Pin Diameter d ₂ max. mm	Inner Width b ₂ max. mm	Linkplate Height g max. mm	Transverse e mm	Pin Width a ₁ max. mm	Overall Width a ₃ max. mm	Bearing Area A cm ²	Required *) Ultimate Strength min. F _B N	Weight ≈ q kg/m	Loose Parts			
	inch	mm												S	C	E	L
08 B – 1 KL	0,50	12,7	7,75	8,51	4,45	11,3	11,6	–	16,7	20,3	0,5	14 000	0,68		x	x	x
10 B – 1 KL	0,625	15,875	9,65	10,16	5,08	13,28	14,7	–	18,9	23,2	0,67	19 000	0,9		x	x	x
12 B – 1 KL	0,75	19,05	11,68	12,07	5,72	15,62	15,9	–	22,3	25,0	0,89	25 000	1,15	x	x	x	x
16 B – 1 KL	1,00	25,4	17,02	15,88	8,28	25,4	20,6	–	35,4	41,9	2,1	53 000	2,6	x	x	x	x

Roller Chains, Double Strand, with Thermoplastic Bearings

Chain No.	Pitch p		Roller Width b ₁ min. mm	Roller Diameter d ₁ max. mm	Pin Diameter d ₂ max. mm	Inner Width b ₂ max. mm	Linkplate Height g max. mm	Transverse e mm	Pin Width a ₁ max. mm	Overall Width a ₃ max. mm	Bearing Area A cm ²	Required *) Ultimate Strength min. F _B N	Weight ≈ q kg/m	Loose Parts			
	inch	mm												S	C	E	L
08 B – 2 KL	0,50	12,7	7,75	8,51	4,45	11,3	11,6	13,92	30,6	34,3	1,01	28 000	1,28		x	x	x
10 B – 2 KL	0,625	15,875	9,65	10,16	5,08	13,28	14,7	16,59	35,5	40,0	1,34	38 000	1,72		x	x	x
12 B – 2 KL	0,75	19,05	11,68	12,07	5,72	15,62	15,9	19,46	41,7	45,5	1,79	50 000	2,27		x	x	x
16 B – 2 KL	1,00	25,4	17,02	15,88	8,28	25,45	20,6	31,88	67,4	73,9	4,21	106 000	5,1			x	x

*) On request, we shall advise the effective higher Rexnord breaking load values and fatigue resistance values.

Hollow Pin Chains

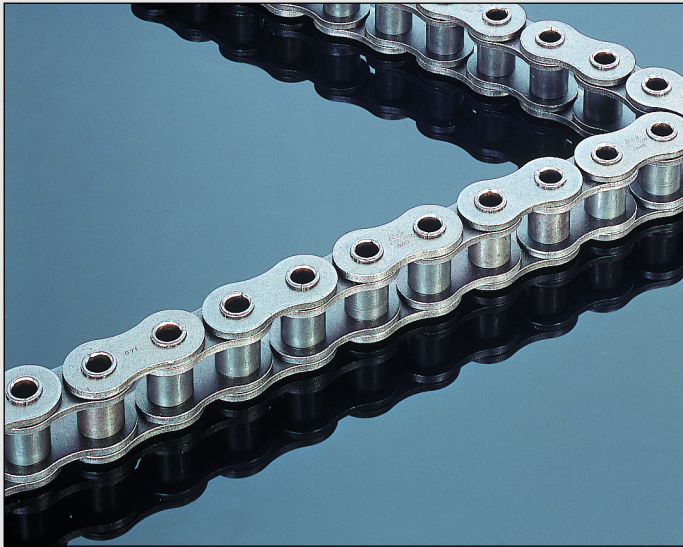

*Flexible Transportation,
Connecting and Joining*

Type A, as Bush Chain

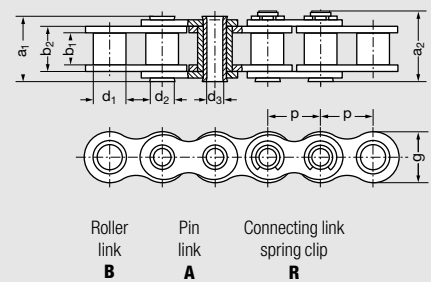

Type B, as Roller Chain

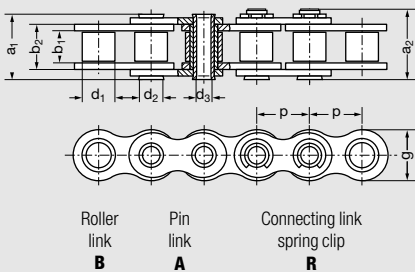

Type C, with Carrier Rollers

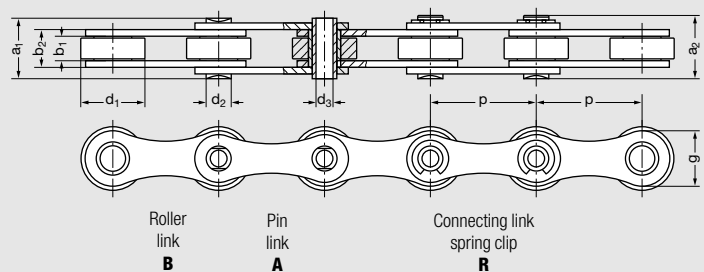

Hollow Pin Chains, Single Strand, Main Dimensions acc. to European and American Standard

Chain No.	Type	Pitch p		Roller Width	Roller Diameter	Pin Diameter	Hollow Pin Inner Diameter	Inner Width	Linkplate Height	Transverse	Pin Width	Overall Width	Bearing Area	Required *) Ultimate Strength min. F_B N	Weight $\approx q$ kg/m	Loose Parts	
		inch	mm	b_1 min. mm	d_1 max. mm	d_2 max. mm	d_3 mm	b_2 max. mm	g max. mm	e mm	a_1 max. mm	a_2 max. mm	A cm^2	$\approx q$ kg/m	C	R	
10 B – 1 HB	B	0,625	15,875	9,65	10,16	5,94	4	13,9	14,7	–	19,3	21,1	1,14	17 000	0,80		x
12 B – 1 HB	B	0,75	19,05	11,68	12,07	6,5	4	16,3	15,9	–	22,4	24,0	1,06	21 000	1,10	x	x
40 HB	A	0,50	12,7	7,85	7,95 1)	5,72	4	11,9	11,6	–	17,1	18,5	0,68	10 000	0,53		x
60 HB	B	0,75	19,05	12,57	11,91	7,0	5	18,65	17,7	–	26,3	27,2	1,30	20 000	1,32	x	x
80 HB	A	1,00	25,4	15,75	15,88 1)	11,67	8	22,5	23,7	–	32,6	33,7	2,63	59 000	2,40	x	x
SK 845	C	2,00	50,8	10,0	30,0	11,6	8,1	16,8	25,6	–	26,4	28,6	1,95	50 000	2,06	x	x

Hollow Pin Chains, Double Strand, Main Dimensions acc. to European and American Standard

Chain No.	Type	Pitch p		Roller Width	Roller Diameter	Pin Diameter	Hollow Pin Inner Diameter	Inner Width	Linkplate Height	Transverse	Pin Width	Overall Width	Bearing Area	Required *) Ultimate Strength min. F_B N	Weight $\approx q$ kg/m	Loose Parts	
		inch	mm	b_1 min. mm	d_1 max. mm	d_2 max. mm	d_3 mm	b_2 max. mm	g max. mm	e mm	a_1 max. mm	a_2 max. mm	A cm^2	$\approx q$ kg/m	C	R	
10 B – 2 HB	B	0,625	15,875	9,65	10,16	5,94	4	13,9	14,7	17,8	37,3	39,0	2,08	33 500	1,6		x
12 B – 2 HB	B	0,75	19,05	11,68	12,07	6,5	4	16,3	15,9	20,6	43,0	45,0	2,12	42 500	2,2	x	x

1) Bushing diameter.

*) On request, we shall advise the effective higher Rexnord breaking load values and fatigue resistance values.

Stainless Steel Roller Chains

Rexnord 4000 Plus



*Corrosion Resistant,
Fatigue Resistant, and Wear Resistant*

Rexnord „SS“-Roller Chains are made from Rexnord’s patented “Plus” Material.

Stainless Steel Roller Chains, Single Strand

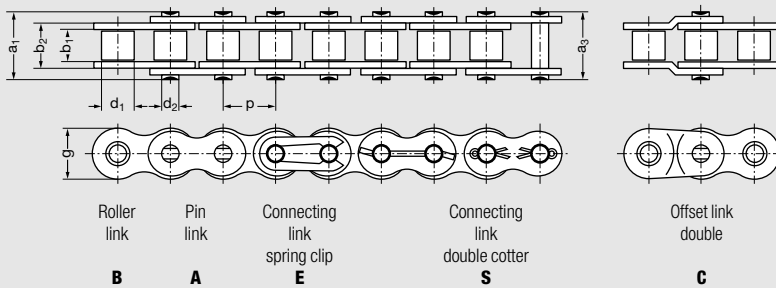

Chain No.	Pitch p		Roller Width b ₁ min. mm	Roller Diameter d ₁ max. mm	Pin Diameter d ₂ max. mm	Inner Width b ₂ max. mm	Linkplate Height g max. mm	Transverse e mm	Pin Width a ₁ max. mm	Overall Width a ₃ max. mm	Bearing Area A cm ²	Required *) Ultimate Strength min. F _B N	Weight ≈ q kg/m	Loose Parts		
	inch	mm												C	E	S
08 B – 1 SS	0,50	12,7	7,75	8,51	4,45	11,3	11,6	–	16,9	18,2	0,50	12 500	0,72	x	x	
10 B – 1 SS	0,625	15,875	9,65	10,16	5,08	13,28	14,6	–	18,9	20,5	0,67	14 500	0,95	x	x	
12 B – 1 SS	0,75	19,05	11,68	12,07	5,72	15,62	15,9	–	22,1	24,7	0,89	18 000	1,2	x	x	x
16 B – 1 SS	1,00	25,4	17,02	15,88	8,28	25,45	20,8	–	35,4	36,7	2,10	40 000	2,7	x	x	
50 SS	0,625	15,875	9,53	10,16	5,08	13,84	15,0	–	20,6	21,8	0,70	18 000	1,03	x	x	

Stainless Steel Roller Chains, Double Strand

Chain No.	Pitch p		Roller Width b ₁ min. mm	Roller Diameter d ₁ max. mm	Pin Diameter d ₂ max. mm	Inner Width b ₂ max. mm	Linkplate Height g max. mm	Transverse e mm	Pin Width a ₁ max. mm	Overall Width a ₃ max. mm	Bearing Area A cm ²	Required *) Ultimate Strength min. F _B N	Weight ≈ q kg/m	Loose Parts		
	inch	mm												C	E	S
08 B – 2 SS	0,50	12,7	7,75	8,51	4,45	11,3	11,6	13,92	30,9	32,0	1,00	22 000	1,40	x	x	
10 B – 2 SS	0,625	15,875	9,65	10,16	5,08	13,28	14,6	16,59	35,5	38,6	1,34	26 000	1,85	x	x	
12 B – 2 SS	0,75	19,05	11,68	12,07	5,72	15,62	15,9	19,46	41,7	42,8	1,78	33 000	2,35	x	x	
16 B – 2 SS	1,00	25,4	17,02	15,88	8,28	25,45	20,8	31,88	67,1	68,6	4,20	73 000	5,2		x	
50 – 2 SS	0,625	15,875	9,53	10,16	5,08	13,84	15,0	18,11	38,6	33,9	1,40	36 000	2,0		x	

*) On request, we shall advise the effective higher Rexnord breaking load values and fatigue resistance values.

Side Bow Roller Chains



For Constructions with Curves

Links A and B available for all chains.
Side bow roller chains with attachments upon request.

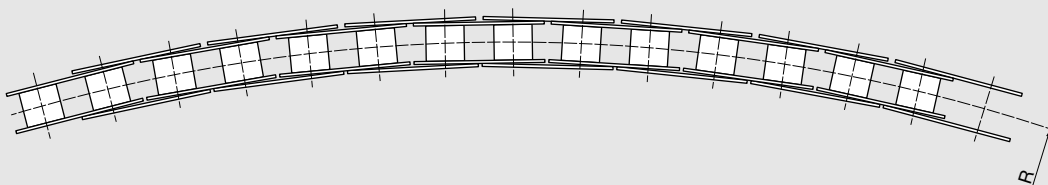
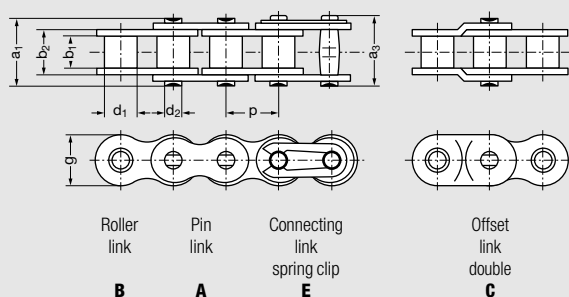

Side Bow Roller Chains, Main Dimensions acc. to European Standard (DIN 8187)

Chain No.	Pitch p		Roller Width b_1 min. mm	Roller Diameter d_1 max. mm	Pin Diameter d_2 max. mm	Inner Width b_2 max. mm	Linkplate Height g max. mm	Pin Width a_1 max. mm	Overall Width a_3 max. mm	Radius R min.	Required *) Ultimate Strength min. F_B N	Weight $\approx q$ kg/m	Loose Parts	
	inch	mm											C	E
08 B - 1 SB	0,50	12,7	7,75	8,51	4,45	11,3	11,8	17,1	18,3	315	11 200	0,71	x	x
10 B - 1 SB	0,625	15,875	9,65	10,16	5,08	13,28	14,7	19,4	20,6	400	15 000	0,92	x	x
12 B - 1 SB	0,75	19,05	11,68	12,07	5,72	15,61	15,9	22,5	23,7	500	20 000	1,2	x	x

Side Bow Roller Chains, Main Dimensions acc. to American Standard (DIN 8188)

Chain No.	Pitch p		Roller Width b_1 min. mm	Roller Diameter d_1 max. mm	Pin Diameter d_2 max. mm	Inner Width b_2 max. mm	Linkplate Height g max. mm	Pin Width a_1 max. mm	Overall Width a_3 max. mm	Radius R min.	Required *) Ultimate Strength F_B N	Weight $\approx q$ kg/m	Loose Parts	
	inch	mm											C	E
40 SB	0,50	12,7	7,85	7,92	3,96	11,18	11,6	16,6	17,8	315	9 000	0,64	x	x
50 SB	0,625	15,875	9,4	10,16	5,08	13,84	14,6	20,8	22,1	400	15 000	1,1	x	x
60 SB	0,75	19,05	12,57	11,91	5,94	17,75	17,7	25,7	27,1	500	22 400	1,5	x	x

*) On request, we shall advise the effective higher Rexnord breaking load values and fatigue resistance values.

Double-Pitch Roller Chains

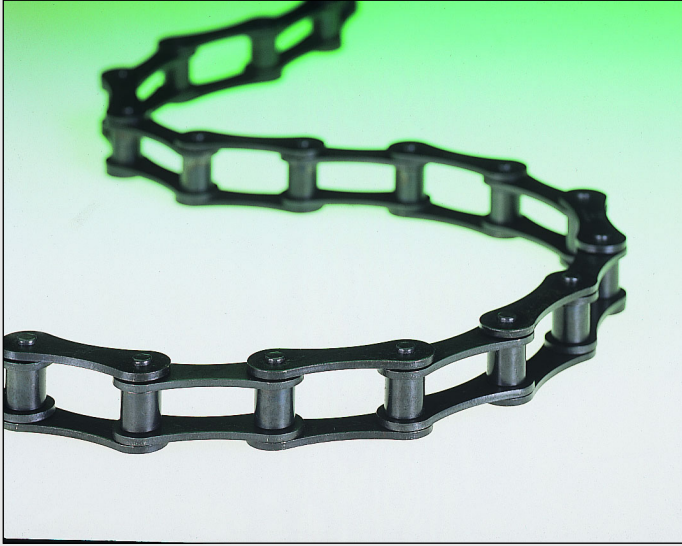

*High Efficiency -
Low Weight*

Links A and B available for all chains.

1) Also available with Delrin Rollers.

Double-Pitch Roller Chains with Straight Link Plates, American Standard

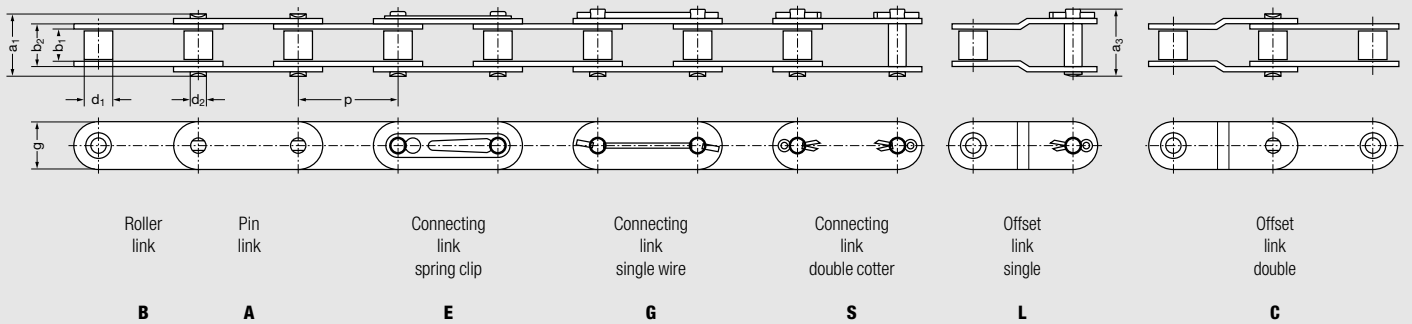

Chain No.	Pitch p		Roller Width b ₁ min. mm	Roller Diameter d ₁ max. mm	Pin Diameter d ₂ max. mm	Inner Width b ₂ max. mm	Linkplate Height g max. mm	Pin Width a ₁ max. mm	Overall Width a ₃ max. mm	Bearing Area A cm ²	Request *) Ultimate Strength min. F _B N	Weight ≈ q kg/m	Loose Parts			
	inch	mm											S	C	E	L
C 2040	1,00	25,4	7,85	7,95	3,96	11,15	11,5	16,3	20,3	0,44	14 100	0,48	x	x	x	x
C 2050	1,25	31,75	9,4	10,16	5,08	13,8	14,5	20,3	24,5	0,7	22 200	0,80	x	x	x	x
C 2060 H	1,50	38,1	12,57	11,91	5,94	19,4	16,8	28,8	32,9	1,15	31 800	1,49	x	x	x	x
C 2080 H	2,00	50,8	15,75	15,88	7,92	24,2	22,8	35,3	41,0	1,92	56 700	2,36	x	x		

*) Breaking load is only a static value. Since almost every drive will be dynamically loaded, on request, we shall advise the effective higher Rexnord breaking load values as well as our effective fatigue resistance values.

Double-Pitch Roller Chains with Straight Link Plates and Carrier Rollers, American Standard

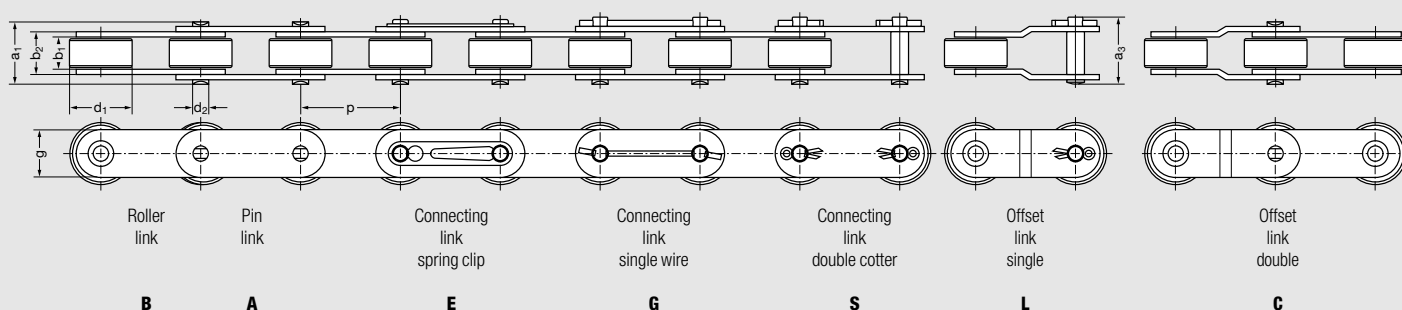

Chain No.	Pitch p		Roller Width b ₁ min. mm	Roller Diameter d ₁ max. mm	Pin Diameter d ₂ max. mm	Inner Width b ₂ max. mm	Linkplate Height g max. mm	Pin Width a ₁ max. mm	Overall Width a ₃ max. mm	Bearing Area A cm ²	Request *) Ultimate Strength min. F _B N	Weight ≈ q kg/m	Loose Parts			
	inch	mm											S	C	E	L
C 2042	1,00	25,4	7,85	15,88	3,96	11,15	11,5	16,3	20,3	0,44	14 100	0,85	x		x	x
C 2052	1,25	31,75	9,4	19,05	5,08	13,8	14,5	20,3	24,5	0,7	22 200	1,27	x		x	x
C 2062 H ¹⁾	1,50	38,1	12,57	22,23	5,94	19,4	16,8	28,8	32,0	1,15	31 800	2,1	x	x	x	x
C 2082 H ¹⁾	2,00	50,8	15,75	28,58	7,93	24,2	22,8	35,9	41,0	1,94	56 700	3,44	x	x		

Double-Pitch Roller Chains

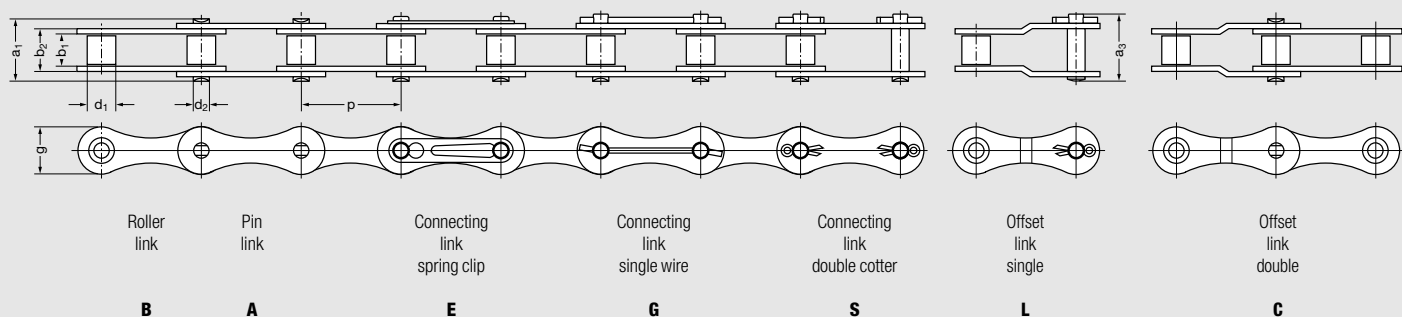

European Standard

Chain No.	Pitch p		Roller Width b ₁ min. mm	Roller Diameter d ₁ max. mm	Pin Diameter d ₂ max. mm	Inner Width b ₂ max. mm	Linkplate Height g max. mm	Pin Width a ₁ max. mm	Overall Width a ₃ max. mm	Bearing Area A cm ²	Request *) Ultimate Strength min. F _B N	Weight ≈ q kg/m	Loose Parts			
	inch	mm											S	C	E	L
208 B	1,00	25,4	7,75	8,51	4,45	11,3	11,5	16,7	18,9	0,50	18 000	0,45	x	x	x	x
210 B	1,25	31,75	9,65	10,16	5,08	13,28	14,5	18,9	21,8	0,67	22 400	0,59	x	x	x	x
212 B	1,50	38,1	11,68	12,07	5,72	15,62	15,9	22,3	24,7	0,89	29 000	0,74	x	x	x	x
216 B	2,00	50,8	17,02	15,88	8,28	25,4	21,4	35,4	38,4	2,10	60 000	1,71	x	x		x

American Standard

Chain No.	Pitch p		Roller Width b ₁ min. mm	Roller Diameter d ₁ max. mm	Pin Diameter d ₂ max. mm	Inner Width b ₂ max. mm	Linkplate Height g max. mm	Pin Width a ₁ max. mm	Overall Width a ₃ max. mm	Bearing Area A cm ²	Request *) Ultimate Strength min. F _B N	Weight ≈ q kg/m	Loose Parts			
	inch	mm											S	C	E	L
208 A	1,00	25,4	7,85	7,95	3,96	11,15	11,5	16,3	19,8	0,44	14 100	0,42	x	x	x	x
210 A	1,25	31,75	9,4	10,16	5,08	13,8	14,5	20,3	24,5	0,7	22 200	0,67	x	x	x	x
212 A	1,50	38,1	12,57	11,91	5,94	17,7	16,8	25,7	29,6	1,05	31 800	1,02	x	x	x	x
216 A	2,00	50,8	15,75	15,88	7,92	22,5	21,4	33,0	37,4	1,78	56 700	1,55	x	x		x

*) On request, we shall advise the effective higher Rexnord breaking load values and fatigue resistance values.

Agricultural Roller Chains



*Reliable and Fatigue Resistant -
Even in Rough Applications*

For double-pitch roller chains as well as for chains of the agricultural series (S-series) we can offer a far reaching programme of standard and special carriers and attachments.

See our Agricultural Chain catalogue.

- V \triangle Reinforced.
- Offset link wire.
- Connecting pin.
- 1) Chains with straight link plates.
- \triangle Also available as bush HL 728 resp. HL 738 (bush \varnothing 10,2 mm).

Agricultural Roller Chains, ISO 487 / DIN 8189

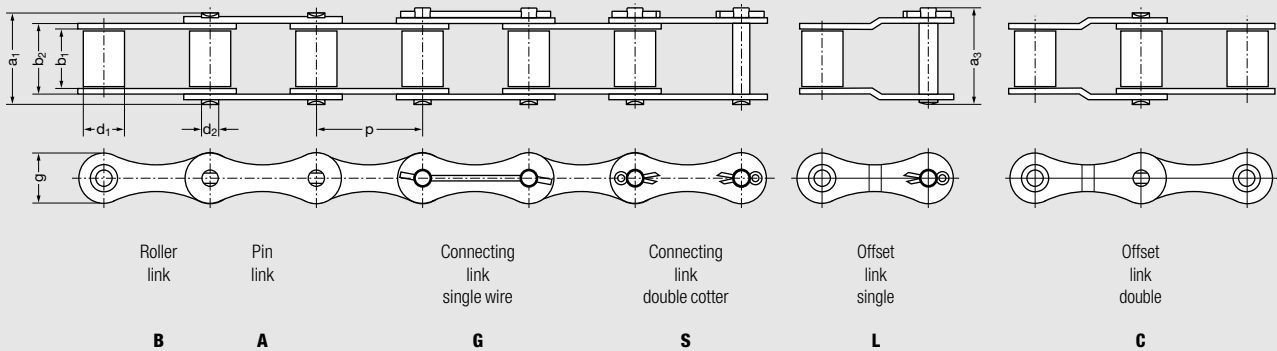

Chain No.	Pitch p		Roller Width b ₁ min. mm	Roller Diameter d ₁ max. mm	Pin Diameter d ₂ max. mm	Inner Width b ₂ max. mm	Linkplate Height g max. mm	Pin Width a ₁ max. mm	Overall Width a ₃ max. mm	Bearing Area A cm ²	Required *) Ultimate Strength min. F _B N	Weight ≈ q kg/m	Loose Parts		
	inch	mm											S	C	L
S 32 V	1,15	29,21	15,88	11,43	4,45	20,19	12,3	26,3	29,6	0,90	18 000	0,82	x		x
S 42 V	1,375	34,93	19,05	14,27	7,0	25,4	17,5	33,9	38,5	1,78	33 500	1,49	x		x
S 45	1,63	41,4	22,23	15,24	5,72	28,58	16,8	37,4	40,6	1,63	25 000	1,55	x	x	x
S 45 V	1,63	41,4	22,23	15,24	5,72	28,58	16,8	37,4	40,6	1,63	33 500	1,55	x	x	x
S 52	1,50	38,1	22,23	15,24	5,72	28,58	16,8	37,4	40,6	1,63	25 000	1,72	x	x	x
S 52 V	1,50	38,1	22,23	15,24	5,72	28,58	16,8	37,4	40,6	1,63	33 500	1,72	x	x	x
S 55	1,63	41,4	22,23	17,78	5,72	28,58	16,8	37,4	40,6	1,63	25 000	1,80	x	x	x
S 55 V	1,63	41,4	22,23	17,78	5,72	28,58	16,8	37,4	40,6	1,63	33 500	1,80	x	x	x
S 62	1,65	41,91	25,4	19,05	5,72	31,8	16,7	39,9	43,8	1,82	28 000	1,95	x		x
S 77	2,30	58,34	22,23	18,26	8,9	31,17	24,6	43,5	49,2	2,77	45 000	2,35	x		x
S 88	2,60	66,27	28,58	22,86	8,9	37,52	24,6	49,9	55,0	3,34	45 000	2,78	x		x

*) On request, we shall advise the effective higher Rexnord breaking load values and fatigue resistance values.

Agricultural Roller Chains, Industry Standard

Chain No.	Pitch p		Roller Width b ₁ min. mm	Roller Diameter d ₁ max. mm	Pin Diameter d ₂ max. mm	Inner Width b ₂ max. mm	Linkplate Height g max. mm	Pin Width a ₁ max. mm	Overall Width a ₃ max. mm	Bearing Area A cm ²	Required *) Ultimate Strength min. F _B N	Weight ≈ q kg/m	Loose Parts			
	inch	mm											S	C	L	
SK 627	1,18	30,0	19,0	15,88	8,28	25,4	20,5	35,4	39,0	2,1	45 000	2,42	x			
RL 726	1,50	38,1	16,0	15,24	5,72	21,07	16,8	29,3	33,8	1,20	33 500	1,32	x			
RL 728 ¹⁾ △	1,50	38,4	18,5	15,88	6,92	24,2	17,0	32,6	36,5	1,67	25 000	1,67	x	x	x	□
RL 738 ¹⁾ △	1,50	38,4	18,5	15,88	6,92	24,2	17,0	32,6	36,5	1,67	31 500	1,67	x	x	x	□
SK 717 ¹⁾	1,50	38,4	19,0	15,88	8,28	25,4	20,0	35,4	39,0	2,1	45 000	2,10	x	x	x	□
RL 753	1,63	41,4	20,5	15,88	7,97	27,0	19,7	37,0	41,6	2,15	42 500	1,75	x	x	x	
RL 764	1,63	41,4	22,23	17,78	8,28	28,58	19,7	38,9	42,8	2,36	47 500	2,03	x		x	
RL 765	1,63	41,4	20,0	15,88	8,28	28,58	20,0	38,9	44,8	2,36	60 000	1,91	x	x	x	
RL 766 ¹⁾	1,63	41,4	22,23	15,88	8,28	31,0	20,2	41,4	44,6	2,56	60 000	2,40				○
RL 774	1,63	41,4	19,5	16,66	7,16	26,0	19,5	35,4	39,7	1,86	47 500	2,00	x		x	
SK 838	2,00	50,8	19,0	19,05	9,53	27,4	25,7	39,4	–	2,61	90 000	2,60	G			

Agricultural Roller Chains with Thermoplastic Bearings

Chain No.	Pitch p		Roller Width b ₁ min. mm	Roller Diameter d ₁ max. mm	Pin Diameter d ₂ max. mm	Inner Width b ₂ max. mm	Linkplate Height g max. mm	Pin Width a ₁ max. mm	Overall Width a ₃ max. mm	Bearing Area A cm ²	Required *) Ultimate Strength min. F _B N	Weight ≈ q kg/m	Loose Parts		
	inch	mm											S	C	L
RLK 728 ¹⁾ △	1,50	38,4	18,5	15,88	6,92	24,2	17,2	32,6	35,8	1,67	23 600	1,63	x	x	x
RLK 744	1,63	41,4	22,23	17,78	5,72	28,58	17,2	36,7	39,8	1,63	25 000	1,77	x		x
RLK 753	1,63	41,4	20,5	16,0	7,97	27,0	20,0	37,0	40,8	2,15	35 500	1,70	x	x	x

*) Breaking load is only a static value. Since almost every drive will be dynamically loaded, on request, we shall advise the effective higher Rexnord breaking load values as well as our effective fatigue resistance values.

Leaf Chains



Safety Lifting Chains

Leaf Chains – Lacings

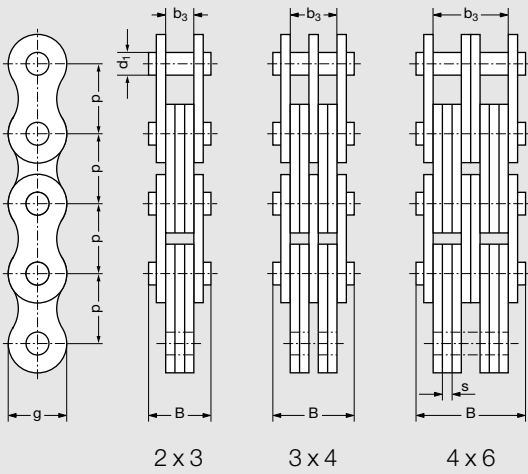

Leaf Chains – Lacings

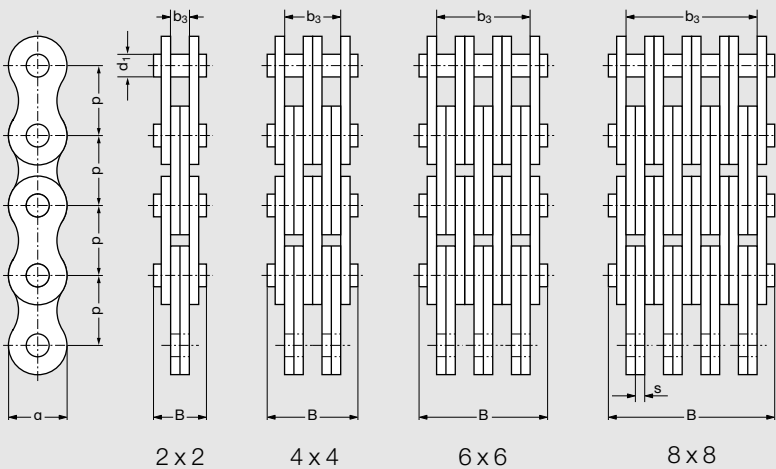

Leaf Chains acc. to DIN 8152, American Standard, Heavy Series

Chain No.	Chain Type	Pitch p		Lacing	Pin Diameter	Plate Height	Plate Thickness	Length exceeding 100 x Pitches	Overall Width	Bearing Area	Inner Width of Outer Plates b ₃ min. mm	Required*) Ultimate Strength min. F _B N	Weight ≈ q kg/m
		inch	mm										
● BL 423	LH 0823	0,50	12,7	2 x 3	5,08	11,6	2,0	1277	12,4	0,3	6,3	22 200	0,65
● BL 434	LH 0834			3 x 4					16,7	0,41	10,5	33 300	0,9
● BL 444	LH 0844			4 x 4					18,9	0,41	12,6	44 400	1,02
● BL 446	LH 0846			4 x 6					22,8	0,61	16,8	44 400	1,26
● BL 466	LH 0866			6 x 6					27,1	0,61	21,0	66 600	1,51
● BL 523	LH 1023	0,625	15,875	2 x 3	5,94	14,6	2,4	1596	14,8	0,43	7,5	33 400	0,9
● BL 534	LH 1034			3 x 4					19,9	0,57	12,5	50 100	1,32
● BL 544	LH 1044			4 x 4					22,5	0,57	15,0	66 800	1,51
● BL 546	LH 1046			4 x 6					27,4	0,86	20,0	66 800	1,86
● BL 566	LH 1066			6 x 6					32,0	0,86	25,0	100 200	2,24
● BL 623	LH 1223	0,75	19,05	2 x 3	7,92	17,8	3,2	1908	19,7	0,76	9,9	48 900	1,76
● BL 634	LH 1234			3 x 4					26,4	1,0	16,5	73 400	2,43
● BL 644	LH 1244			4 x 4					29,5	1,0	19,8	97 800	2,76
● BL 646	LH 1246			4 x 6					35,9	1,5	26,4	97 800	3,43
● BL 666	LH 1266			6 x 6					42,4	1,5	33,0	146 900	4,1
● BL 823	LH 1623	1,00	25,4	2 x 3	9,53	23,6	3,9	2544	24,6	1,11	12,0	84 500	3,0
● BL 834	LH 1634			3 x 4					33,1	1,48	20,0	126 800	4,234
● BL 844	LH 1644			4 x 4					37,4	1,48	24,0	169 000	4,72
● BL 846	LH 1646			4 x 6					45,5	2,22	32,0	169 000	5,86
● BL 866	LH 1666			6 x 6					54,0	2,22	40,0	253 600	7,0
● BL 1023	LH 2023	1,25	31,75	2 x 3	11,1	29,2	4,7	3179	28,6	1,56	14,4	115 600	4,35
● BL 1034	LH 2034			3 x 4					38,7	2,09	24,0	173 400	6,05
● BL 1044	LH 2044			4 x 4					43,6	2,09	28,8	231 200	6,9
● BL 1046	LH 2046			4 x 6					53,3	3,12	38,4	231 200	8,5
● BL 1066	LH 2066			6 x 6					63,3	3,12	48,0	346 800	10,25
● BL 1223	LH 2423	1,50	38,1	2 x 3	12,7	34,4	5,5	3812	33,6	2,1	16,8	151 200	5,8
● BL 1234	LH 2434			3 x 4					45,5	2,79	28,0	226 800	8,0
● BL 1244	LH 2444			4 x 4					51,2	2,79	33,6	302 400	9,1
● BL 1246	LH 2446			4 x 6					62,7	4,2	44,8	302 400	11,4
● BL 1266	LH 2466			6 x 6					74,5	4,2	56,0	453 600	13,6
● BL 1288	LH 2488	8 x 8	97,8	5,4	78,4	604 800	17,9						
● BL 1423	LH 2823	1,75	44,45	2 x 3	14,27	40,8	6,3	4445	38,2	2,7	19,2	191 300	7,9
● BL 1434	LH 2834			3 x 4					51,7	3,6	32,0	287 000	11,0
● BL 1444	LH 2844			4 x 4					58,2	3,6	38,4	382 600	12,6
● BL 1446	LH 2846			4 x 6					71,5	5,4	51,2	382 600	15,7
● BL 1466	LH 2866			6 x 6					85,0	5,4	64,0	574 000	18,8
● BL 1623	LH 3223	2,00	50,8	2 x 3	17,46	47,9	7,1	5080	42,1	3,8	21,6	289 100	9,0
● BL 1634	LH 3234			3 x 4					57,0	5,0	36,0	433 700	12,5
● BL 1646	LH 3246			4 x 6					78,9	7,6	57,6	578 200	17,8
● BL 1666	LH 3266			6 x 6					95,0	7,6	72,0	867 400	21,3
● BL 1688	LH 3288			8 x 8					125,6	10,0	100,8	1 156 400	28,3

BL Leaf Chains can be directly fastened by means of connecting pins.

You do not need any additional endplates.

It is desirable to select a BL Chain where possible.

● Stock sizes.

■ Chain length tolerance: $\pm 0,25\%$ of unlubricated chain under force measurement. Force measurement = $\frac{F_B}{100}$

F = Pin and link plate dimensions according to DIN 8187 (BS) roller chain.

AL = Pin and link plate dimensions according to DIN 8188 (ANSI) roller chain.

BL = Pin and link plate dimensions according to ANSI standard, however, the plate dimensions and pin diameter are those of the next largest size. This provides increased bearing area and tensile strength for longer wear-life with reduced outer dimensions.

*) On request, we shall advise the effective higher Rexnord breaking load values.

Leaf Chains

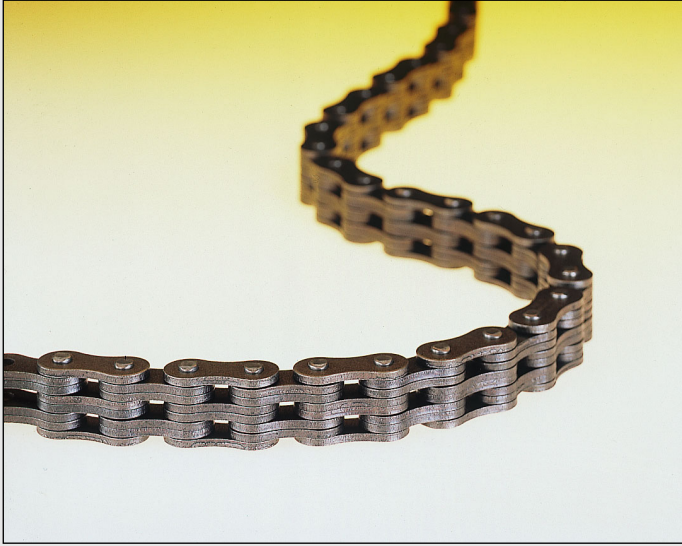

**F Series:
Machine Tool Quality**

The effective pitch dimensions of F and AL leaf chains are different from basic dimensions.
Please pay attention to “Length exceeding 100 x Pitches”.

Please use for machine tools chains of “F”-series in special machine tool quality.

- Stock sizes.
 - Chain length tolerance: $\pm 0,25\%$ of unlubricated chain under force measurement.
- Force measurement = $\frac{F_B}{100}$

Leaf Chains – Lacings

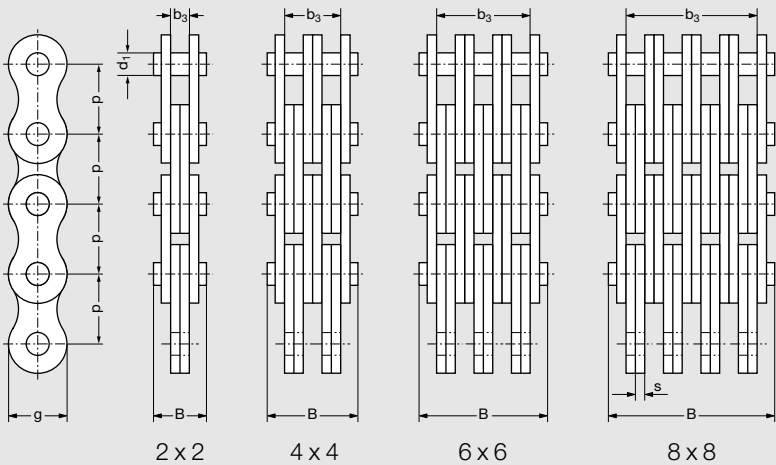

Leaf Chains, Industry Standard

Chain No.	Chain Type	Pitch p		Lacing	Pin Diameter	Plate Height	Plate Thickness	Length exceeding 100 x Pitches	Overall Width	Bearing Area	Required *) Ultimate Strength min.	Weight
		inch	mm									
F 6 H - 5	-	0,625	15,875	2 x 3	4,75	14,6	2,5	1592	14,9	0,24	30 300	1,0
● F 19 V - 44	-	0,75	19,05	4 x 4	6,5	15,2	2,35	1901	22,4	0,61	71 000	1,75
● F 19 V - 66	-	-	-	6 x 6	-	-	-	-	32,3	0,91	106 000	2,6
834 (SK 507)	-	1,00	25,4	3 x 4	10,85	23,4	IL /AL	2544	28,4	1,37	125 000	3,6
432 (SK 508)	-	-	-	6 x 6	-	-	3,05/4,0	-	44,4	2,06	250 000	5,9

*) On request, we shall advise the effective higher Rexnord breaking load values.

Leaf Chains acc. to DIN 8152, European Standard, Light Series

Chain No.	Chain Type ISO DIN	Pitch p		Lacing	Pin Diameter d ₁ max. mm	Plate Height g max. mm	Plate Thickness s mm	Length exceeding 100 x Pitches ■ mm	Overall Width B max. mm	Bearing Area A cm ²	Inner Width of Outer Plates b ₃ min. mm	Required *) Ultimate Strength min. F _B N	Weight ≈ q kg/m
		inch	mm										
● F 12 – 44	LL 0844	0,50	12,7	4 x 4	4,45	10,4	1,5	1258	15,1	0,27	9,7	36 000	0,83
● F 12 – 66	LL 0866			6 x 6					21,4	0,40	16,1	54 000	1,25
● F 15 – 44	LL 1044	0,625	15,875	4 x 4	5,08	12,8	1,5	1588	15,1	0,30	9,7	44 800	0,94
● F 15 – 66	LL 1066			6 x 6					21,4	0,46	16,1	67 200	1,4
● F 19 – 44	LL 1244	0,75	19,05	4 x 4	5,72	15,9	1,8	1888	18,0	0,41	11,5	59 000	1,3
● F 19 – 66	LL 1266			6 x 6					25,2	0,62	19,1	88 500	2,3
● F 25 – 44	LL 1644	1,00	25,4	4 x 4	8,28	20,5	3,0	2540	28,2	0,99	18,6	120 000	2,8
● F 25 – 66	LL 1666			6 x 6					40,5	1,49	31,0	180 000	4,2
● F 25 – 88	LL 1688			8 x 8					54,2	1,98	43,4	240 000	5,2
● F 31 – 44	LL 2044	1,25	31,75	4 x 4	10,19	25,7	3,5	3160	33,3	1,42	21,6	190 000	4,2
● F 31 – 66	LL 2066			6 x 6					48,2	2,12	36,0	285 000	6,3
● F 31 – 88	LL 2088			8 x 8					63,2	2,83	50,4	380 000	8,4
● F 38 – 44	LL 2444	1,50	38,1	4 x 4	14,63	33,0	5,0	3785	46,9	2,91	30,6	320 000	8,2
● F 38 – 66	LL 2466			6 x 6					68,3	4,37	51,0	480 000	12,0
● F 38 – 88	LL 2488			8 x 8					89,7	5,82	71,4	640 000	16,3
● F 44 – 22	LL 2822	1,75	44,45	2 x 2	15,9	36,0	6,0	4410	29,4	1,9	72,2	200 000	4,8
● F 44 – 44	LL 2844			4 x 4					54,7	3,8	36,6	400 000	9,5
● F 44 – 66	LL 2866			6 x 6					80,2	5,7	61,0	600 000	14,1
● F 50 – 22	LL 3222	2,00	50,8	2 x 2	17,81	41,2	6,3	5048	32,5	2,24	12,8	250 000	6,2
F 50 – 44	LL 3244			4 x 4					59,1	4,47	38,4	500 000	11,9
F 50 – 66	LL 3266			6 x 6					85,4	6,71	64,0	750 000	17,8
● F 50 – 88	LL 3288			8 x 8					112,0	8,94	89,6	1 000 000	23,8
F 63 – 22	LL 4022	2,50	63,5	2 x 2	22,89	48,0	8,0	6325	39,5	3,65	16,2	355 000	9,2
F 63 – 44	LL 4044			4 x 4					73,1	7,3	48,6	710 000	17,9
F 63 – 66	LL 4066			6 x 6					106,5	10,94	81,0	1 065 000	26,6
F 76 – 44	LL 4844	3,00	76,2	4 x 4	29,24	62,0	10,0	7597	91,2	11,66	60,6	1 120 000	29,6
F 76 – 66	LL 4866			6 x 6					131,0	17,5	101,0	1 680 000	44,0

Leaf Chains, American Standard, Light Series

Chain No.	Chain Type ISO DIN	Pitch p		Lacing	Pin Diameter d ₁ max. mm	Plate Height g max. mm	Plate Thickness s mm	Length exceeding 100 x Pitches ■ mm	Overall Width B max. mm	Bearing Area A cm ²	Inner Width of Outer Plates b ₃ min. mm	Required *) Ultimate Strength min. F _B N	Weight ≈ q kg/m
		inch	mm										
● AL 422	–	0,50	12,7	2 x 2	3,96	10,2	1,5	1257	8,1	0,12	3,2	14 100	0,35
● AL 444	–			4 x 4					14,5	0,23	9,6	28 200	0,67
● AL 466	–			6 x 6					20,9	0,35	16,0	42 300	1,0
● AL 522	–	0,625	15,875	2 x 2	5,08	12,8	2,0	1566	10,5	0,2	4,2	22 000	0,63
● AL 544	–			4 x 4					18,7	0,4	12,6	44 000	1,2
● AL 566	–			6 x 6					27,1	0,6	21,0	66 000	1,75
● AL 622	–	0,75	19,05	2 x 2	5,94	14,8	2,4	1905	12,6	0,28	5,0	37 000	0,93
● AL 644	–			4 x 4					22,5	0,57	15,0	63 600	1,6
● AL 666	–			6 x 6					32,0	0,85	25,0	95 400	2,5
AL 688	–			8 x 8					43,0	1,14	35,0	127 200	3,3
● AL 844	–	1,00	25,4	4 x 4	7,92	20,5	3,1	2540	30,8	1,01	19,2	113 400	3,3
● AL 866	–			6 x 6					44,4	1,52	32,0	170 100	4,9
AL 1044	–	1,25	31,75	4 x 4	9,53	25,7	3,9	3175	37,3	1,52	24,0	177 000	4,9
● AL 1066	–			6 x 6					54,0	2,29	40,0	265 500	7,3
● AL 1266	–	1,50	38,1	6 x 6	11,1	29,4	4,7	3810	63,3	3,12	48,0	381 000	10,5
● AL 1288	–			8 x 8					83,0	4,17	67,2	508 000	14,0
AL 1466	–	1,75	44,45	6 x 6	12,7	36,0	5,5	4445	74,5	4,2	56,0	558 000	13,0
AL 1666	–			2,00					50,8	6 x 6	14,27	41,2	6,3

*) On request, we shall advise the effective higher Rexnord breaking load values.

Fastening of Leaf Chains

Connecting Pins for Fastening Leaf Chains

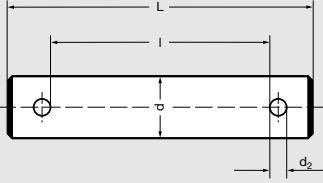

For sizes exceeding BL 1234 / F 38 the connecting pin is supplied with additional 2 plates.

Chain No.	Connecting Pin Order No.	Dimensions of Connecting Pins in mm			
		l min.	L max.	d max.	d ₂
F 12 - 44 F 12 - 66	● 709 - 204 - 44 ● 709 - 204 - 66	16,0 23,0	22,2 29,2	4,45	1,6
F 15 - 44 F 15 - 66	● 709 - 205 - 44 ● 709 - 205 - 66	15,0 22,0	21,1 28,2	5,08	1,6
F 19 - 44 F 19 - 66	● 709 - 405 - 44 ● 709 - 405 - 66	17,6 24,7	25,5 32,7	5,72	2,0
F 25 - 44 F 25 - 66 F 25 - 88	● 709 - 208 - 44 ● 709 - 208 - 66 ● 709 - 208 - 88	28,0 41,0 54,0	38,7 51,7 64,7	8,28	3,2
F 31 - 44 F 31 - 66 F 31 - 88	● 709 - 210 - 44 ● 709 - 210 - 66 ● 709 - 210 - 88	33,0 47,0 62,0	43,7 57,7 72,7	10,19	3,2
F 38 - 44 F 38 - 66 F 38 - 88	● 709 - 214 - 44 ● 709 - 214 - 66 ● 709 - 214 - 88	48,2 69,2 90,2	60,6 81,6 102,6	14,63	4,0
F 44 - 22 F 44 - 44 F 44 - 66 F 44 - 88	● 709 - 215 - 22 ● 709 - 215 - 44 709 - 215 - 66 709 - 215 - 88	29,7 55,0 80,2 106,0	42,1 67,5 92,7 118,5	15,9	4,0
F 50 - 22 F 50 - 44 F 50 - 66 F 50 - 88	● 709 - 217 - 22 709 - 217 - 44 709 - 217 - 66 ● 709 - 217 - 88	34,4 59,9 86,4 113,9	51,9 77,5 104,0 131,5	17,81	5,0
F 63 - 22 F 63 - 44 F 63 - 66 F 63 - 88	709 - 222 - 22 709 - 222 - 44 709 - 222 - 66 709 - 222 - 88	39,9 73,3 106,6 140,1	60,8 94,3 127,6 161,1	22,89	6,3
F 76 - 44 F 76 - 66 F 76 - 88	709 - 229 - 44 709 - 229 - 66 709 - 229 - 88	91,5 133,5 174,2	112,5 154,5 195,2	29,23	6,3
F 19 V - 44 F 19 V - 66	709 - 206 - 44 709 - 206 - 66	23,0 33,0	30,2 40,3	6,5	2,0

Chain No.	Connecting Pin Order No.	Dimensions of Connecting Pins in mm			
		l min.	L max.	d max.	d ₂
BL 422/AL 522 BL 423 BL 434 BL 444/AL 544 BL 446 BL 466/AL 566 BL 488/AL 588	● 709 - 305 - 22 ● 709 - 305 - 23 ● 709 - 305 - 34 709 - 305 - 44 ● 709 - 305 - 46 709 - 305 - 66 709 - 305 - 88	10,8 12,7 17,0 19,0 23,0 27,0 35,5	17,0 18,9 23,2 25,2 29,2 33,3 41,8	5,08	1,6
BL 522 BL 523 BL 534 BL 544/AL 644 BL 546 BL 566/AL 666 BL 588/AL 688	709 - 355 - 22 ● 709 - 355 - 23 ● 709 - 355 - 34 ● 709 - 355 - 44 ● 709 - 355 - 46 ● 709 - 355 - 66 709 - 355 - 88	12,8 15,0 20,0 22,5 27,0 32,0 42,5	19,4 21,6 26,6 29,1 33,7 38,7 49,3	5,94	2,0
BL 623 BL 634 BL 644/AL 844 BL 646 BL 666/AL 866 BL 688/AL	● 709 - 307 - 23 ● 709 - 307 - 34 ● 709 - 307 - 44 ● 709 - 307 - 46 ● 709 - 307 - 66 709 - 307 - 88	20,0 27,0 30,0 37,0 43,0 56,5	30,7 37,7 40,7 47,7 53,7 67,2	7,92	3,2
BL 823 BL 834 BL 844/AL 1044 BL 846 BL 866/AL 1066 BL 888/AL 1088	● 709 - 309 - 23 ● 709 - 309 - 34 ● 709 - 309 - 44 ● 709 - 309 - 46 ● 709 - 309 - 66 709 - 309 - 88	25,0 33,0 37,0 46,0 53,0 69,5	35,7 43,7 47,7 56,7 63,7 80,3	9,53	3,2
BL 1023 BL 1034 BL 1044/AL 1244 BL 1046 BL 1066/AL 1266 BL 1088/AL 1288	● 709 - 311 - 23 ● 709 - 311 - 34 709 - 311 - 44 ● 709 - 311 - 46 ● 709 - 311 - 66 ● 709 - 311 - 88	30,0 39,2 44,2 54,2 63,2 79,9	42,4 51,6 56,6 66,6 75,6 92,4	11,1	4,0
BL 1223 BL 1234 BL 1244/AL 1444 BL 1246 BL 1266/AL 1466 BL 1288/AL 1488	709 - 312 - 23 709 - 312 - 34 709 - 312 - 44 ● 709 - 312 - 46 709 - 312 - 66 ● 709 - 312 - 88	34,5 46,2 50,0 63,5 75,3 98,6	46,9 58,6 64,4 76,0 87,8 111,1	12,7	4,0
BL 1423 BL 1434 BL 1444 BL 1446 BL 1466	709 - 314 - 23 709 - 314 - 34 ● 709 - 314 - 44 ● 709 - 314 - 46 ● 709 - 314 - 66	38,7 52,2 58,6 71,7 85,1	51,1 64,6 71,1 84,2 97,7	14,27	4,0
BL 1623 BL 1634 BL 1644 BL 1646 BL 1666 BL 1688	● 709 - 317 - 23 ● 709 - 317 - 34 ● 709 - 317 - 44 ● 709 - 317 - 46 ● 709 - 317 - 66 ● 709 - 317 - 88	43,1 58,0 65,7 79,9 94,6 124,0	60,6 75,5 82,9 97,4 112,2 141,6	17,46	5,0

● Stock sizes.

Fastening Blocks

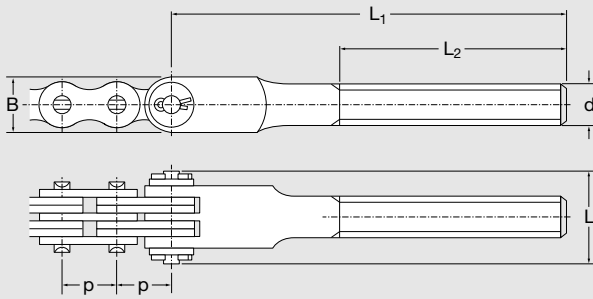

Chain No.	Pitch p		Outer Thread \varnothing d	Block Height B mm	Pin Length L mm	Distance		Thread Length
	inch	mm				L ₁ mm	L ₂ mm	
BL 5-23	0,625	15,875	M 14	20	21,6	172	140	
BL 5-34	0,625	15,875	M 14	20	26,6	172	140	
BL 5-46	0,625	15,875	M 16	20	33,7	172	140	
BL 6-23	0,75	19,05	M 20	25	30,7	178	140	
BL 6-34	0,75	19,05	M 20	25	37,7	178	140	
BL 6-46	0,75	19,05	M 20	25	47,7	178	140	
BL 8-23	1,00	25,4	M 20	25	35,7	178	140	
BL 8-34	1,00	25,4	M 20	25	43,7	178	140	
BL 8-46	1,00	25,4	M 20	25	56,7	178	140	

Recommendations for Dimensions of Fastening Blocks

Lacings

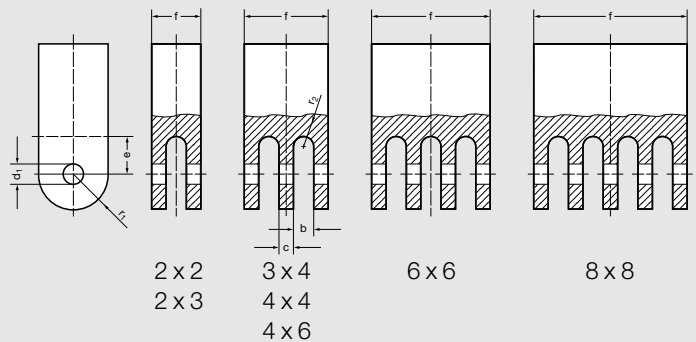

Chain No.	Dimensions in mm						
	f max.	b min.	c max.	d ₁ D 10	e min.	r ₁ max.	r ₂ max.
BL 422/AL 522	10,7	4,2	—				2,0
BL 423	12,6	6,4	—				3,0
BL 434	16,9	4,2	2,0				2,0
BL 444/AL 544	18,9	4,2	4,0	5,1	9,0	6,5	2,0
BL 446	22,9	6,4	4,0				3,0
BL 466/AL 566	26,9	4,2	4,0				2,0
BL 488/AL 588	35,4	4,2	4,0				2,0
BL 522	12,7	5,0	—				2,0
BL 544/AL 644	22,4	5,0	4,8				2,0
BL 566/AL 666	31,9	5,0	4,8	6,0	11,0	8,0	2,0
BL 588/AL 688	42,4	5,0	4,8				2,0
BL 644/AL 844	29,9	6,8	6,4				3,0
BL 666/AL 866	42,9	6,8	6,4	8,0	14,0	9,5	3,0
BL 688/AL 888	56,4	6,8	6,4				3,0
BL 844/AL 1044	36,9	8,5	8,0				4,0
BL 866/AL 1066	52,9	8,5	8,0	9,6	18,0	12,5	4,0
BL 888/AL 1088	69,4	8,5	8,0				4,0
BL 1023	29,8	15,1	—				7,0
BL 1034	39,0	10,0	4,7				5,0
BL 1044/AL 1244	44,0	10,0	9,4				5,0
BL 1046	54,0	15,1	9,4	11,2	22,0	15,0	7,0
BL 1066/AL 1266	63,0	10,0	9,4				5,0
BL 1088/AL 1288	79,7	10,0	9,4				5,0
BL 1223	34,3	17,7	—				8,0
BL 1234	46,0	11,8	5,5				5,0
BL 1244/AL 1444	49,0	11,8	11,0				5,0
BL 1246	63,3	17,7	11,0	12,8	26,0	19,0	8,0
BL 1266/AL 1466	75,1	11,8	11,0				5,0
BL 1288/AL 1488	98,4	11,8	11,0				5,0
BL 1423	38,5	20,1	—				10,0
BL 1434	52,0	13,4	6,3				6,0
BL 1444	58,4	13,4	12,6	14,3	31,0	22,0	10,0
BL 1446	71,5	20,1	12,6				10,0
BL 1466	84,9	13,4	12,6				10,0
BL 1623	42,8	22,5	—				10,0
BL 1634	57,7	15,0	7,1				7,0
BL 1644	65,4	15,0	14,2				7,0
BL 1646	79,6	22,5	14,2	17,5	34,0	25,0	10,0
BL 1666	94,3	15,0	14,2				7,0
BL 1688	123,7	15,0	14,2				7,0

Chain No.	Dimensions in mm						
	f max.	b min.	c max.	d ₁ D 10	e min.	r ₁ max.	r ₂ max.
F 12-44	15,9						
F 12-66	22,9	3,5	3,0	4,5	7,3	6,5	1,7
F 15-44	14,9						
F 15-66	21,9	3,5	3,0	5,1	8,5	8,0	1,7
F 19-44	17,5						
F 19-66	24,6	4,1	3,6	5,75	10,0	9,5	1,7
F 25-44	27,9						
F 25-66	40,9	6,7	6,2	8,3	13,5	13,0	3,0
F 25-88	53,9						
F 31-44	32,9						
F 31-66	46,9	7,5	7,0	10,2	17,0	16,5	3,5
F 31-88	61,9						
F 38-44	48,0						
F 38-66	69,0	11,0	10,0	14,7	22,0	20,0	5,0
F 38-88	90,9						
F 44-22	29,5						
F 44-44	54,8						
F 44-66	80,0	13,0	12,0	16,0	25,0	24,0	6,0
F 44-88	105,8						
F 50-22	34,2						
F 50-44	59,7						
F 50-66	86,2	13,6	12,6	17,9	28,0	27,0	6,0
F 50-88	113,7						
F 63-22	39,6						
F 63-44	73,0						
F 63-66	106,3	17,0	16,0	23,0	35,0	35,0	8,0
F 63-88	139,8						
F 76-44	91,2						
F 76-66	133,2	21,0	20,0	29,3	45,0	40,0	10,0
F 76-88	173,9						
F 19 V-44	22,9						
F 19 V-66	32,9	5,2	4,7	6,6	10,0	10,5	2,0

Fastening of Leaf Chains

Endplates as Inner Link

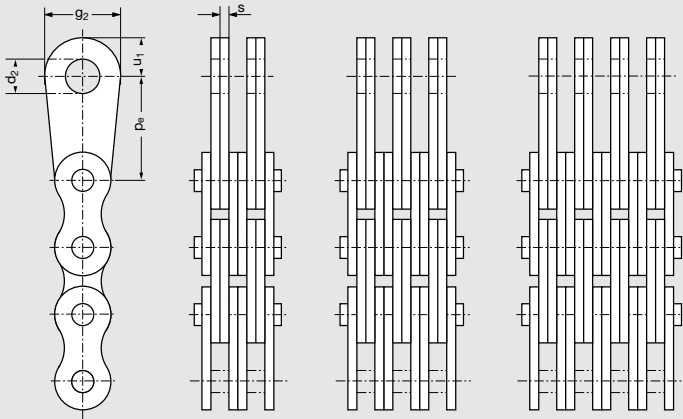

Scope of delivery :
Endplate and outer link for rivetting are parts of our delivery program.

Endplates as Outer Link

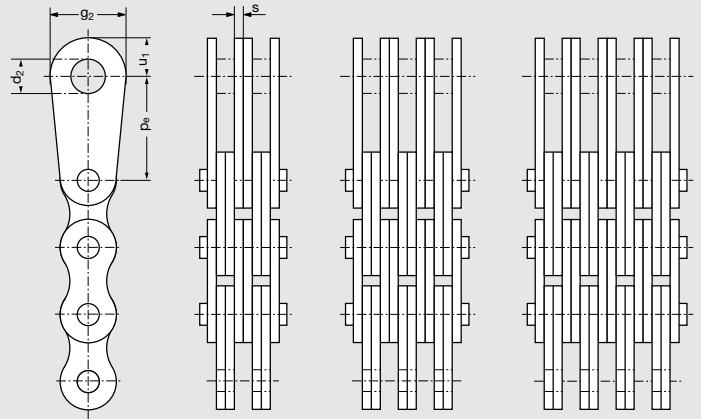

Scope of delivery:
Endplate and rivet pin are parts of our delivery program.

Chain No.	Endplates Order No.		Dimensions in mm				
	IEG	AEG	Pe	d ₂ A11	g ₂	s	u ₁
F 12 - 44 F 12 - 66	170 - 112 - 44 170 - 112 - 66	45 65	15	6	16,0	1,7	10,0
F 15 - 44 F 15 - 66	170 - 115 - 44 170 - 115 - 66	45 65	20	8	18,0	1,5	11,0
F 25 - 44 F 25 - 66 F 25 - 88	170 - 124 - 44 170 - 124 - 66 170 - 124 - 88	45 65 85	30	12	25,0	3,0	15,0
F 31 - 44 F 31 - 66 F 31 - 88	170 - 131 - 44 170 - 131 - 66 170 - 131 - 88	45 65 85	50	18	40,0	3,5	25,0
F 38 - 44 F 38 - 66 F 38 - 88	170 - 138 - 44 170 - 138 - 66 170 - 138 - 88	45 65 85	65	24	50,0	5,0	29,0
F 44 - 22 F 44 - 44 F 44 - 66	170 - 144 - 22 170 - 144 - 44 170 - 144 - 66	25 45 65	80	28	60,0	6,0	32,0
F 50 - 22 F 50 - 88	170 - 150 - 22 170 - 150 - 88	25 85	90	32	70,0	6,3	43,0
F 63 - 44 F 63 - 66	170 - 163 - 44 170 - 163 - 66	45 65	100	38	80,0	8,0	46,5
AL 644 AL 666 AL 688	170 - 118 - 44 170 - 118 - 66 170 - 118 - 88	45 65 85	25	10	19,8	2,4	11,2
AL 1044 AL 1066	170 - 130 - 44 170 - 120 - 66	45 65	40	14	30,0	4,0	18,0
F 19 V 44 F 19 V 66	170 - 120 - 44 170 - 120 - 66	45 65	25	10	19,8	2,35	11,2

Endplates are available as inner and outer links.
Chain and outer link will be connected with connecting pin (page 34).

Example for ordering Endplates for leaf chain F 38-44:

- a) as inner link (IEG): 170-138-44
- b) as outer link (AEG): 170-138-45

Offset Sidebar Chains



Chains for Drum Drives

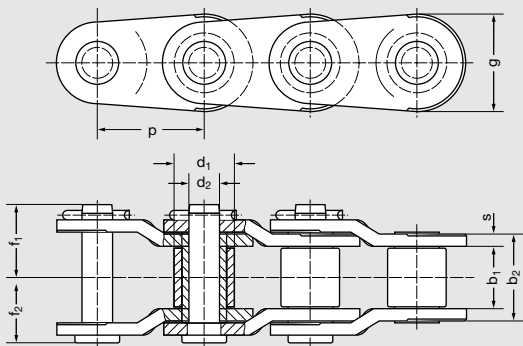

Type A

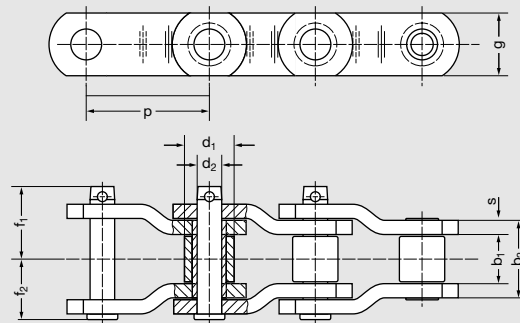

Type B

Owing to design and dimensional changes in 1989 some measurements have been altered.

Please check if the offset sidebar chain should be connected with end blocks, chain anchors etc.

It is not possible to replace parts of the chain (pins and links) between the old one produced up to and including 1988 and the new one produced in 1989 and in future.

- 1) Similar Ro 3 c.
- Replaced by 1037.

Rex Chain No.	Chain No.	Pitch p		Roller Width b ₁ min. mm	Roller Diameter d ₁ max. mm	Pin Diameter d ₂ max. mm	Inner Width b ₂ max. mm	Linkplate Height g max. mm	Plate Thickness s mm	f ₁ mm	f ₂ mm	Bearing Area A cm ²	Required *) Ultimate Strength min. F _B N	Weight ≈ q kg/m	Type
		inch	mm												
3160	Ro 20	2,0	50,8	30,56	28,58	14,27	44,7	48,0	6,35	37,6	33,9	6,4	222 500	9,9	A
B 3113	Ro 20 H	2,0	50,8	30,56	28,58	15,06	47,6	41,5	8,0	41,3	38,1	7,1	231 400	10,9	A
R 1035	Ro 3	3,075	78,1	36,90	31,75	15,875	54,0	41,5	8,0	46,9	41,3	8,5	271 500	11,0	B
Champ.-Nr.3	Ro 3 c □	3,075	78,1	36,90	31,75	16,46	57,2	43,0	9,5	50,0	44,9	9,4	298 200	10,9	B
1037 1)		3,075	78,1	36,5	31,75	16,46	57,2	44,5	9,5	50,0	45,2	9,4	280 400	12,8	B
AX1568	Ro 3 b	3,067	77,9	38,5	41,28	19,05	58,8	57,5	9,5	53,2	46,1	11,2	400 500	18,0	B
RX 238	Ro 3 ½	3,5	88,9	36,9	44,45	22,22	63,5	57,5	12,7	61,2	52,8	14,1	556 300	23,6	B
1244	Ro 4	4,063	103,2	48,0	44,45	22,22	74,6	54,0	12,7	66,7	58,4	16,6	476 200	19,4	B
RX1245	Ro 4 b	4,073	103,45	47,6	45,24	23,81	77,8	60,5	14,3	69,9	62,4	18,5	650 000	27,9	B
Ro 635	Ro 4 ½	4,5	114,3	50,8	57,15	27,78	81,0	76,5	14,3	71,5	65,1	22,5	894 500	32,9	B
Ro 1207	Ro 5 b	5,0	127,0	68,3	63,5	31,75	101,6	89,0	15,9	82,6	74,3	32,2	1 161 500	52,5	B
Ro 1306	Ro 6	6,0	152,4	74,6	76,2	38,1	114,3	102,0	19,0	97,7	84,6	43,5	1 646 500	67,1	B

*) On request, we shall advise the effective higher Rexnord breaking load values and fatigue resistance values.

Laschenkette

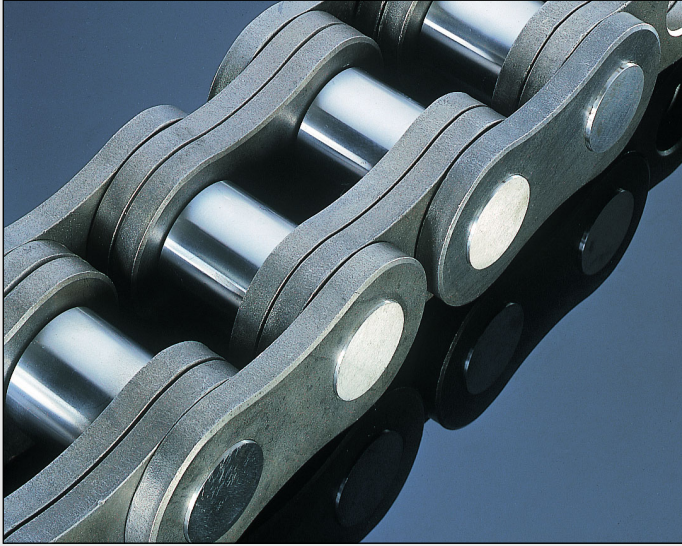

*For Straddle Carriers
and Extreme Demands*

Laschenkette 64-1 S BG

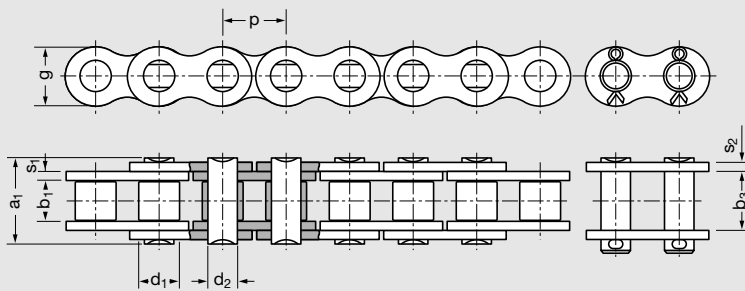

Dirt and grease on roller chain very often leads to the fact that that oil cannot penetrate into the chain hinges. Under the same maintenance and lubrication conditions the hinges of Laschenkette can be supplied much better with lubricant. This is due to the shorter distance the oil has to travel to reach the pin. The optimised clearances in the hinge area also helps eliminate corrosion problems, e.g. pitting corrosion.

The Rexnord Laschenkette is primarily being used for lifting purposes in straddle carriers. This new development in chain focuses on the non-usage of life-critical chain bushings and in optimising the remaining chain parts. Two main features are:

- a) Duplication of movable plates
- b) Stronger pins with additional 50% surface area and additional 85% section modulus.

Practical tests of Laschenkette on straddle carriers in several ports and on test stands have shown a 3-5 times longer working life than standard roller chain.

Laschenkette RLK 50-1 SL/A, Laschenkette 64-1 S / SH / SH BK

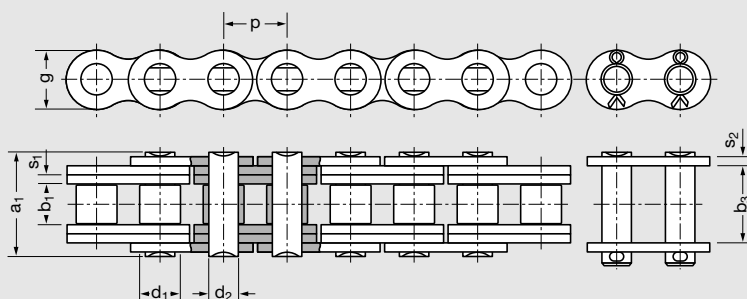

Laschenkette RLK 50-2 SL/A

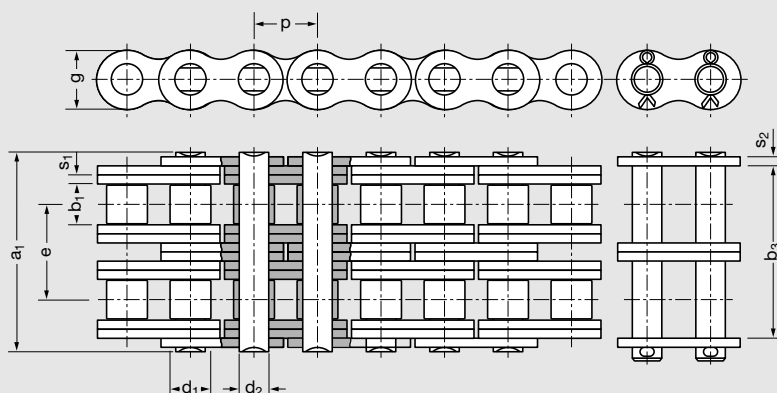

Technical Data

Chain No.	Pitch p		Roller Width b ₁ min. mm	Roller Diameter d ₁ max. mm	Pin Diameter d ₂ max. mm	Outer Width b ₃ min. mm	Transverse e mm	Linkplate Height g max. mm	Overall Width a ₁ max. mm	Plate Thickness		Bearing Area A cm ²	Ultimate Strength ca. F _B N	Weight ≈ q kg/m
	inch	mm								s ₁ mm	s ₂ mm			
50 - 1 SL/A	2,00	50,8	31,55	28,58	20,35	57,5	–	47,8	75,5	6,3	6,3	5,1	270 000	14,9
50 - 2 SL/A	2,00	50,8	31,55	28,58	20,35	128,0	70,5	47,8	146,0	6,3	6,3	10,2	540 000	29,4
64 - 1 S	2,50	63,5	38,1	39,38	30,0	77,0	–	59,5	104,0	9,5	9,5	11,4	530 000	28,0
64 - 1 SBG	2,50	63,5	39,1	39,38	30,0	59,0	–	59,5	83,0	9,5	8,0	5,7	450 000	27,9
64 - 1 SH	2,50	63,5	38,1	39,38	30,0	71,5	–	59,5	101,0	8,0	11,0	9,6	600 000	25,5
64 - 1 SHBK	2,50	63,5	27,6	39,38	30,0	67,0	–	59,5	95,0	9,5	11,0	11,4	600 000	27,5

Construction of Laschenkette

Laschenkette is constructed in a similar way to Leaf chain (plates and pins only). Therefore in a lifting application the wear resistance and reliability of Laschenkette and Leaf chain are comparable.

A high wearing component of Roller chain, the bushing, is not used in Laschenkette. The rollers are fitted directly on to the pins, which are larger in diameter. This feature improves the meshing between the roller chain and the sprocket teeth.

With this improved interaction between chain and sprocket it also benefits the synchronisation of lifting in straddle carriers.

Advantages in Practical Applications

- ▶ Reduction of chain replacements; you will achieve a 3-5 fold increase in service life.
- ▶ High cost reductions; 2-3 less sets of chain required.
- ▶ Reduction in downtimes.
- ▶ Increase in reliability and calculated time for chain replacement.

Marine Diesel Roller Chains

Extended service reliability achieved by optimum fatigue resistance

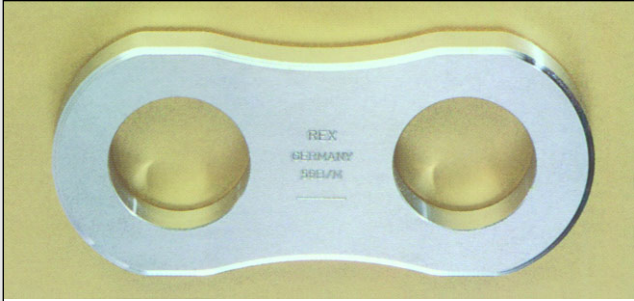
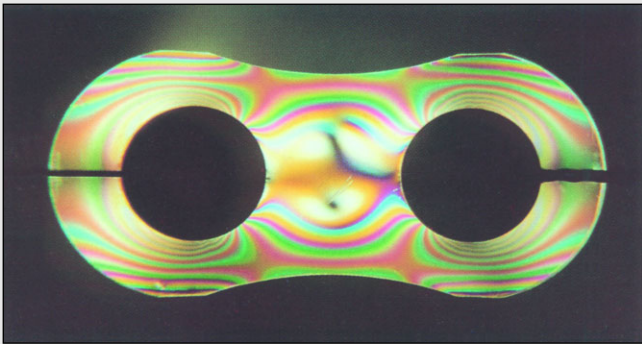

Photo of an inner link plate with new design.



Optical illustration of stress lines.

The shape of the new designed Rexnord inner link plate results in the greatest possible fatigue resistance value.

During research and development parameters like link plate height and other features such as plate thickness, eccentric profile of link plate head, material strength and manufacturing methods were all considered.

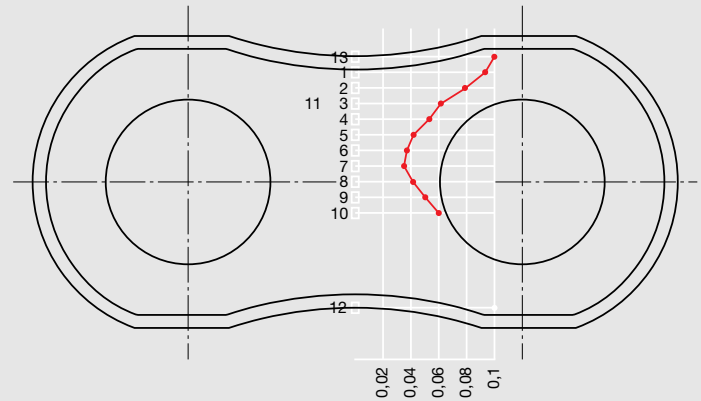

Measuring of tension in the link plate by means of wire strain gauge.

Rexnord research findings

The plate of the inner link is the specific part of a roller chain which determines the fatigue resistance and in consequence the safety of the complete roller chain.

Only a chain with highest fatigue resistance guarantees a trouble-free running during whole wear life.

As a result of extensive research and development a new plate

design has been developed which increases fatigue resistance by more than 30 %.

Full stress analysis has been carried out to balance the link plate height limitation with the cross section and the increase of length in link plate head.

Assembly of the connecting link

Easy assembly and joining of chains is possible. Due to the shoulder on the connecting pin and the fact that head of the pin's not hardened.

Note:

Marine Diesel Roller Chains should also be considered for use on critical drives in industrial applications. They would be particularly advantageous on drives operating on the limits of standard Roller Chain, as well as those drives requiring high efficiency and reliability, but especially to replace chain drives susceptible to fatigue fractures.

Roller Chains, Single Strand, DIN 8187/ISO R 606 (Marine Diesel)

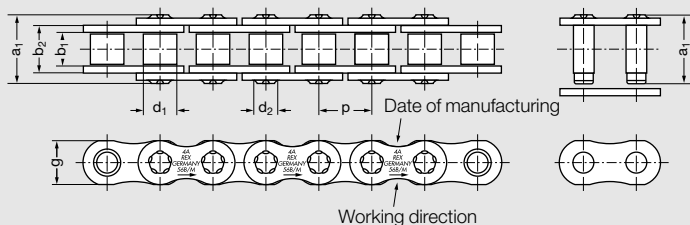

Chain No.	Pitch p		Roller Width b ₁ min. mm	Roller Diameter d ₁ max. mm	Pin Diameter d ₂ max. mm	Inner Width b ₂ max. mm	Linkplate Height g max. mm	Transverse e mm	Pin Width a ₁ max. mm	Bearing Area A cm ²	Required *) Ultimate Strength min. F _B N	Weight ≈ q kg/m
	inch	mm										
40 B - 1 M	2,50	63,5	38,1	39,37	22,89	55,7	55,3	—	82,6	12,75	355 000	17,0
48 B - 1 M	3,00	76,2	45,72	48,26	29,24	70,5	65,3	—	98,5	20,63	560 000	26,0
56 B - 1 M	3,50	88,9	53,34	53,98	34,32	81,3	80,3	—	114,0	27,9	850 000	37,0
64 B - 1 M	4,00	101,6	60,96	63,5	39,4	92,0	93,3	—	130,0	36,25	1 120 000	50,0
72 B - 1 M	4,50	114,3	68,58	72,39	44,5	103,0	105,3	—	147,0	46,19	1 400 000	65,0

Roller Chains, Double Strand, DIN 8187/ISO R 606 (Marine Diesel)

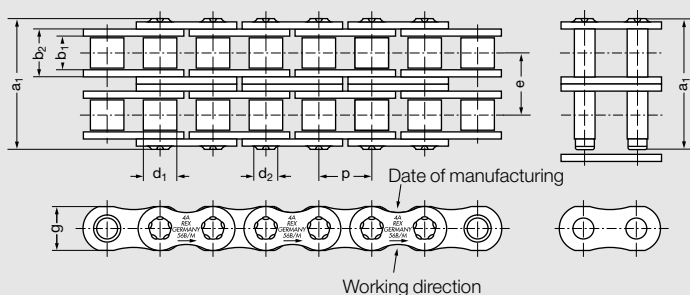

Attention: If multiple strands of single chains are used in the same drive all strands must be delivered as a matched pair or group. Please indicate when ordering.

Chain No.	Pitch p		Roller Width b ₁ min. mm	Roller Diameter d ₁ max. mm	Pin Diameter d ₂ max. mm	Inner Width b ₂ max. mm	Linkplate Height g max. mm	Transverse e mm	Pin Width a ₁ max. mm	Bearing Area A cm ²	Required *) Ultimate Strength min. F _B N	Weight ≈ q kg/m
	inch	mm										
40 B - 2 M	2,50	63,5	38,1	39,37	22,89	55,7	55,3	72,29	154,0	25,5	630 000	34,0
48 B - 2 M	3,00	76,2	45,72	48,26	29,24	70,5	65,3	91,21	190,0	41,23	1 000 000	53,0
56 B - 2 M	3,50	88,9	53,34	53,98	34,32	81,3	80,3	106,6	221,0	55,8	1 600 000	74,0
64 B - 2 M	4,00	101,6	60,96	63,5	39,4	92,0	93,3	119,89	250,0	72,5	2 000 000	98,0
72 B - 2 M	4,50	114,3	68,58	72,39	44,5	103,8	105,3	136,27	283,0	92,4	2 500 000	128,0

*) On request, we shall advise the effective higher Rexnord breaking load values and fatigue resistance values.

Matching of timing roller chains

If two or more chains for the same drive are being used an exact matching of chains is of utmost importance.

Rexnord method of matching of individual chain length and selective composition of these length ensures extreme high precision over the complete chain length.

Rexnord chains guarantee even load distribution between chains and sprockets.

Rexnord chain matching meets all requirements of engine manufacturers.

Quality features of Rexnord Marine Diesel Roller Chains

- Rexnord chain parts are all shot-peened.
- Rexnord link plate bores are produced to very high tolerances and surface finish.
- Rexnord chain pins and bushings are especially wear resistant due to large case depths.
- Rexnord chains are preloaded.
- Rexnord chain rollers have a high strength because they are through hardened and manufactured from high precision seamless tube.
- Rexnord chains manufacture is supported by the expertise built up over many generations and backed by material, production and inspection data which is kept for 10 years.
- Rexnord chains are precision made which results in an even load distribution.
- Rexnord offers a complete quality assurance in each production step.
- Rexnord Marine Diesel roller chains have exceptionally high fatigue resistance to give complete reliability.

Fastening Dimensions for Roller Chains, European and American Standard

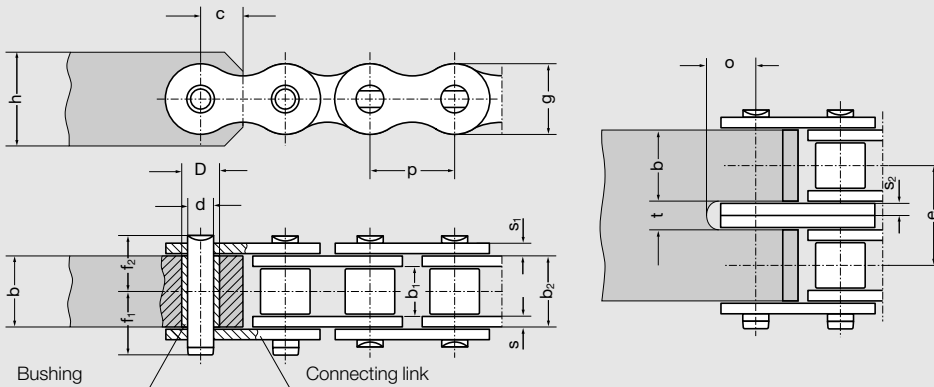

Material strength of the fastening units must be at least 490 N/mm².
 With dynamic load we recommend equipping the fastening unit with a bushing, since it has a surface hardness of approx. 60 HRC and increases the wear resistance considerably.
 Normal static loads do not require a hardened bushing.

These bushings can be supplied by Rexnord. Please indicate the corresponding drawing no. in your order.
 When a bushing is inserted into a D^{S7} bore, the bore of the bushing becomes D^{C10}. In case no bushings are applied D^{C10} can be directly into the fastening unit.

Fastening Dimensions for Roller Chains, European Standard, DIN 8187

ISO No.	Pitch p		Roller Width b ₁ min. mm b ₂ max. mm	Inner Width	Plate Thickness			g mm	e mm	f ₁ mm	f ₂ mm	h mm	b max. mm	c mm	Bore-Ø		t mm	o mm	Bushing Part No.
	inch	mm			s mm	s ₁ mm	s ₂ mm								d ^{C10} mm	D ^{S7} mm			
08 B	0,50	12,7	7,75	11,3	1,7	1,7	1,25	11,6	13,92	10,3	8,4	11	11,2	6,0	4,45	6,27	2,7	7,5	001544
10 B	0,625	15,875	9,65	13,28	1,7	1,5	1,5	14,6	16,59	11,3	9,4	13	13,2	7,5	5,08	7,0	3,2	8,0	001543
12 B	0,75	19,05	11,68	15,62	1,8	1,8	1,8	15,9	19,46	13,2	11,1	16	15,6	10,0	5,72	8,4	3,8	9,5	001542
16 B	1,00	25,4	17,02	25,4	3,75	3,05	3,05	20,5	31,88	21,6	17,7	20	25,4	14,0	8,28	11,7	6,4	13,0	001541
20 B	1,25	31,75	19,56	29,0	4,5	3,5	3,5	25,7	36,45	24,1	20,2	26	29,0	16,5	10,19	14,0	7,4	16,5	001449
24 B	1,50	38,1	25,4	37,9	5,8	5,0	5,0	33,0	48,36	31,6	26,9	33	37,9	19,5	14,63	18,99	10,6	20,0	001540
28 B	1,75	44,45	30,99	46,5	6,5	5,5	6,0	37,0	59,56	36,6	31,6	36	46,5	23,0	15,90	21,64	12,6	24,0	001539
32 B	2,00	50,8	30,99	45,5	6,3	6,3	6,3	41,2	58,55	38,4	32,5	42	45,5	27,0	17,81	23,12	13,2	27,0	001538
40 B	2,50	63,5	38,1	55,7	8,5	8,0	8,0	51,5	72,29	47,5	39,4	52	55,7	35,0	22,89	29,18	16,6	35,0	017776
48 B	3,00	76,2	45,72	70,5	12,0	10,0	10,0	63,5	91,21	56,0	49,2	64	70,5	40,0	29,24	37,9	20,6	40,0	001535
56 B	3,50	88,9	53,34	81,3	13,6	12,0	12,0	77,0	106,6	64,8	57,8	77	81,3	45,0	34,32	43,5	25,0	51,0	001536

Fastening Dimensions for Roller Chains, American Standard, DIN 8188

ANSI No.	Pitch p		Roller Width b ₁ min. mm b ₂ max. mm	Inner Width	Plate Thickness			g mm	e mm	f ₁ mm	f ₂ mm	h mm	b max. mm	c mm	Bore-Ø		t mm	o mm	Bushing Part No.
	inch	mm			s mm	s ₁ mm	s ₂ mm								d ^{C10} mm	D ^{S7} mm			
40	0,50	12,7	7,85	11,15	1,5	1,5	1,5	11,6	14,38	11,2	8,1	11	11,1	6,0	3,96	5,98	3,2	7,0	001662
50	0,625	15,875	9,4	13,8	2,0	2,0	2,0	14,6	18,11	12,0	10,2	13	13,8	7,7	5,08	7,65	4,2	9,0	001523
60	0,75	19,05	12,57	17,7	2,4	2,4	2,4	17,6	22,78	14,4	12,8	16	17,6	9,0	5,94	9,0	5,0	10,0	001522
80	1,00	25,4	18,75	22,5	3,05	3,05	3,05	23,5	29,29	20,4	16,5	22	22,3	12,0	7,92	11,67	6,8	14,0	001521
100	1,25	31,75	18,98	27,4	4,0	4,0	4,0	28,7	35,76	23,7	19,7	26	27,4	15,5	9,53	13,82	8,4	17,5	001520
120	1,50	38,1	25,22	35,3	4,7	4,7	4,7	34,4	45,44	30,0	24,9	30	35,2	18,5	11,10	16,13	9,8	20,0	001519
140	1,75	44,45	25,22	37,0	5,5	5,5	5,5	40,8	48,87	31,6	26,7	36	37,0	21,5	12,70	18,29	11,6	23,5	001518
160	2,00	50,8	31,55	45,0	6,3	6,3	6,3	47,8	58,55	36,4	31,8	42	44,7	24,0	14,27	20,7	13,2	27,5	001517
180	2,25	57,15	35,72	50,5	7,0	7,0	7,0	54,0	65,35	41,4	35,7	47	50,6	27,0	17,46	25,35	14,6	32,0	001516
200	2,50	63,5	37,85	54,7	8,0	8,0	8,0	60,0	71,55	45,0	39,0	52	54,6	30,0	19,84	28,38	16,6	34,5	001515
240	3,0	76,2	47,35	67,5	9,5	9,5	9,5	70,0	87,83	55,5	47,4	62	67,5	37,0	23,8	34,28	19,6	41,0	001514

Proper and Improper Lubrication of Chains and Recommendations for Use

***Operational Reliability and Service Life
by Effective Lubrication***

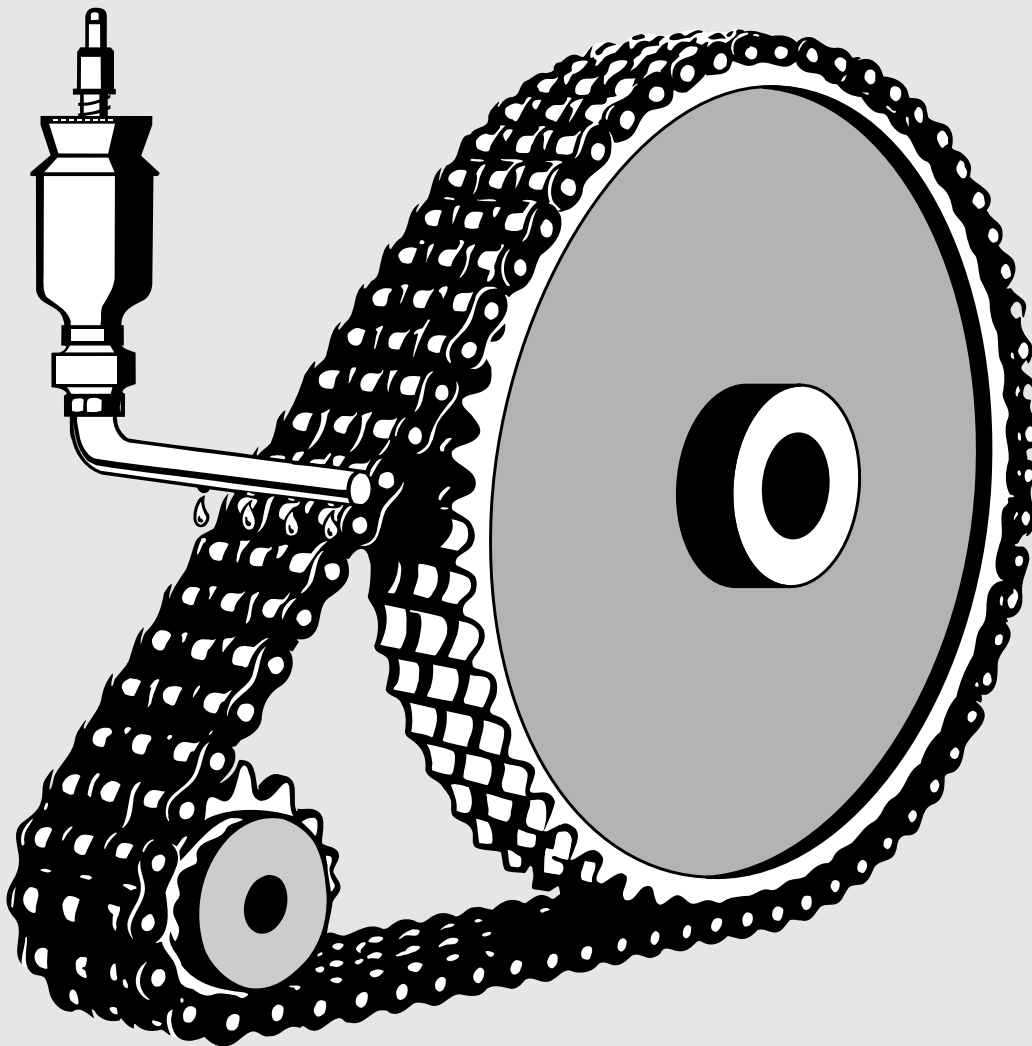

Proper and Improper Lubrication of Roller Chains

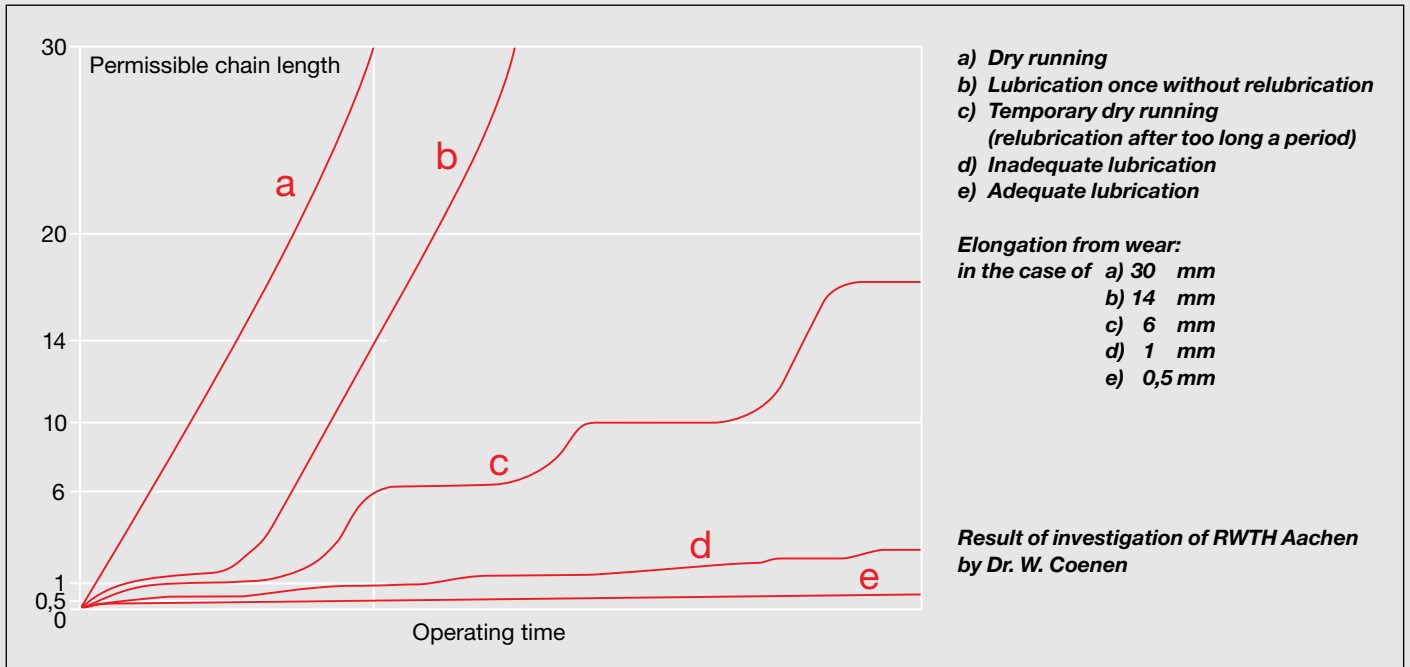

Fig. 1: Elongation from wear as a function of lubrication and operating time

It is up to you to achieve a 60-fold, 12-fold or an only inadequate service life.

Simple and unproblematic as the lubrication of drive chains may appear – a lot of mistakes are being made – as demonstrated by the high percentage of breakdowns caused by faulty lubrication in relation of all chain defects.

Based on our experience the following will describe the most common lubrication faults, their causes and results and will serve as a guide to proper chain lubrication.

Lubrication faults

The wear life of a chain depends decisively on good lubrication. Unfortunately even today improper lubrication and wrongly applied lubrication products cause an adverse effect, i. e. high wear and premature failure. Statistics have shown that 60 % of all chain failures are a direct result of improper lubrication.

The availability of chain lubricants in spray cans has measurably increased during the past years. In many cases the sprays contain a thinner which evaporates after application and leaves a tough non flowing lubrication film. The same type of products might also be offered and applied for chain lubrication in a variety of other container forms.

Lubrication practice

In practice those thickening non liquid lubricants achieve the formation of a lube film in the chain joints at the first relubrication. Since only at that time the lubricant passes between the side plate gaps. Later lubrication generally only causes additional layers of grease on the outside of rollers and side plates with resultant dust collection. Making the flow of lubricants into the chain joints impossible.

The outward appearance of the chain as well as the advertising of the spray can suggest to the user that the chain is receiving optimum lubrication, however, in most cases the opposite is true.

Lubrication check up

Checking the effectiveness of the lubricant applied can be achieved easily by checking the pin of the connecting link. A thoroughly lubricated chain's pin should have a lubrication film on the entire surface and the load side surface should reflect like a mirror after removal of the lubricant.

If lines or even rust appear this is evidence of improper lubrication. A further indication of poor lubrication is a stiffening of certain chain links and their inability to return in a straight line under load.

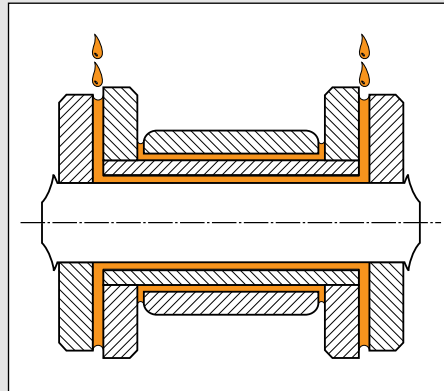

Fig. 2: Graphical picture of a chain link.

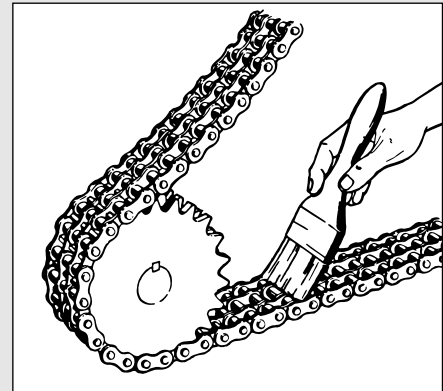

Fig. 3: Chain lubrication by brush.

Consequences of poor lubrication

The use of incorrect lubricants which under normal conditions are too thick to enter the chain joints causes dry friction in the joint.

In addition this furthers the formation of gaps in the joints which will certainly collect condensation. Friction and surface corrosion caused by condensation are inevitable.

Premature chain failures

Since new chains have very little play between the pin and the bush, the likelihood of joints seizing up is dramatically increased without adequate lubrication.

After this initial period, however, the wear between the pin and the sideplates will develop to such an extent that the tolerances will exceed an acceptable limit, resulting in the inner link rotating the pin in the press fit outer link.

This will cause premature failure.

In less serious cases rapid elongation will occur as a result of corrosion and stiff joints. A symptom of this can be "bleeding" of the pins.

Criteria of proper chain lubrication

Standard of lubricants

To achieve effective lubrication it is necessary that at each application sufficient quantities of liquid lubricant are introduced into the chain joints. The graphically shown chain link in **fig 2** demonstrates that the lubricant has to pass a narrow gap between the sideplates in order to enter the chain joint which consists of pin and bush.

The lubricant must pass a narrow gap and therefore must be applied to the edge of the sideplate.

Lubricant

A thin mineral, machine, motor or gear oil should always be used.

Viscosity

The lubricant oil's viscosity should be chosen so that it will remain fluid at all occurring ambient temperatures. Therefore, under usual and normal temperature conditions lubricating oils with a viscosity from SAE 20 to SAE 40 (50 to 2000 mm²/s at 40 °C) are suitable.

If you wish to use spray cans to lubricate chains, make sure that the basic requirement is fulfilled here also, i. e. a viscosity must set in after evaporation of the thinner which will conform to the above requirement.

Rexnord's High Performance Chain Spray reliably fulfils all demands placed on a lubricant for lifting chains.

Without FCKW and CFC.

Lubrication Methods

Manual lubrication

For chain drives with a speed up to 5 m/sec. the so called manual lubrication may be used. The oil is applied by means of a brush (**fig. 3**), spout can or spray can (**fig. 4**) which should, however, contain a thin, well flowing lubricant.

Rexnord High Performance Chain Spray – developed by Rexnord – is suitable for most applications.

Certificated
acc. to USDA-H 2
for the food
producing industry

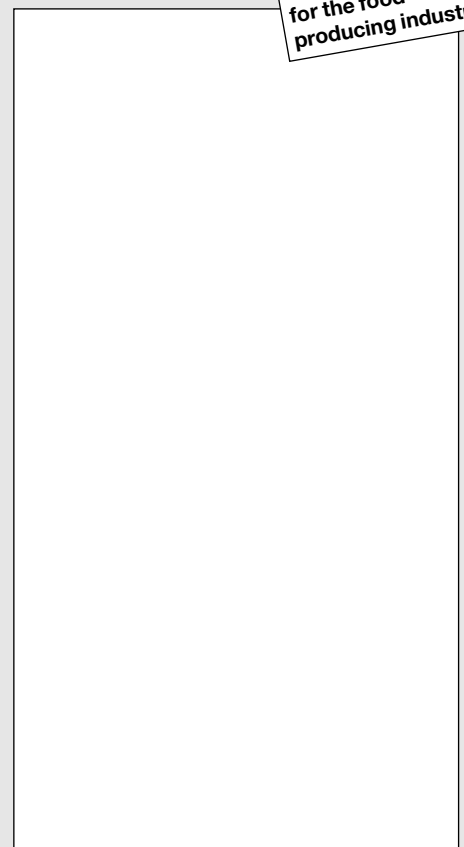

Fig. 4: Chain lubrication by spray can.

Water displacement, high adhesive force and excellent corrosion protection of this product make it suitable for chains used in outdoor applications, especially for lifting chains in fork lift trucks.

The propellant used in Rexnord High Performance Chain Spray is CFC free.

The use of an oil drip system (fig. 5) ensures continuous lubrication and makes lubrication easy, safe, economic and low pollution.

Drip lubrication

Chain speeds between .5 m/sec. to 1.5 m/sec. are suited to the drip method (fig. 6) applied to the upper part of side plates only as shown in picture 6.

Oil bath lubrication

For chain speeds from 1.5 m/sec. to 8 m/sec. the oil bath lubrication is recommended (fig. 7). For ranges between 4 – 8 m/sec. an oil stirring disc should be installed next to the sprocket and only this disc may be immersed in the oil to avoid the formation of foam.

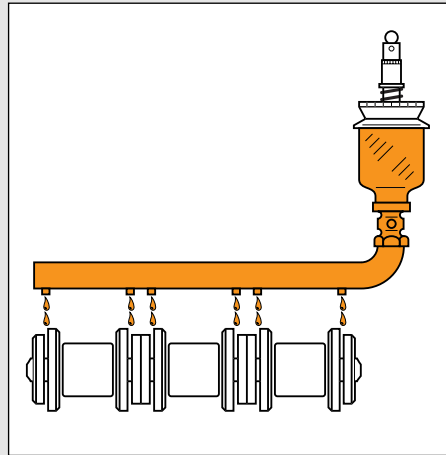

Fig. 6: Drip lubrication.

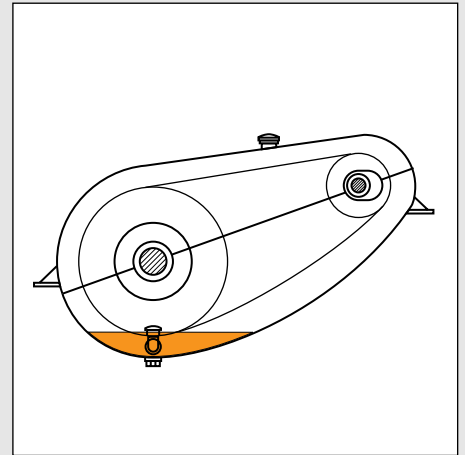

Fig. 7: Oil bath lubrication.

Correct cleaning of chains

If a chain has become externally so soiled during operation that thorough penetration of the lubricating oil is not guaranteed, then the chain must be cleaned. This must be done only with paraffin derivatives such as diesel fuel, petroleum or petroleum ether etc.

We must warn against cleaning with steam jets, the use of cold cleansing agents or even caustic and acidic agents. These may lead to direct chain damage

Summary

Finally it should be mentioned again that the most important function of chain lubrication is to always have sufficient lubricant in the chain joints. Only thin oils ensure the required dosage. Larger chains from 1 1/2" pitch – require lubricant volume not normally available from spray cans.

Greases and lubricants which harden after application should not be used, particularly those containing a high proportion of molybdenum disulphide or graphite.

These build up grease collars which then prevent any further lubrication reaching the bearing area of the chain.

Certificated
acc. to USDA-H 2
for the food
producing industry



Fig. 5:
Easy lubrication with the
oil drip system.

Practical Recommendations for the Application of Chain Drives

Lubrication

The lubrication of chains should be such, that they are always covered, over the entire surface with well running oil i. e. joint parts and side plates have to be oily at all times.

Chain installation

All sprockets forming part of a chain drive must be installed in such a manner that correct alignment is ensured during the entire operation. Alignment can be considered to be sufficient if there is no latitudinal force of the chain.

The sprocket shafts should be as far as possible parallel – max. permitted deviation 3°. Obviously they should also run without sideways pulsation.

Chain tension

Each chain drive must have a certain amount of slack on the return run, to ensure smooth and quiet running condition.

The return strand should have approx. 2 to 3% slack in relation to the axial distance.

The preferred chain drive arrangement should be to have the driven strand above the return strand.

Chain drives with reversing operation should not have any slack since this would cause a delay in the change of direction. However, for this application sprockets should have at least 21 teeth to avoid unnecessary dynamic loads and noise. If the shaft distance is more than 1 m both strands must be supported by guides (reverse operation only).

Permissible chain wear

Chain elongation results from friction between pin and bush in roller chains and pin and plates in leaf chain. This should be a maximum of 3% (30 mm/m). Thereafter the chain should be replaced. This maximum value decreases if sprockets have more than 67 teeth. The following formula applies:

$$\text{Permissible chain stretch: } \frac{200}{Z_2} \%$$

Z_2 = number of teeth on large sprocket.

Chains should always be changed if there are signs of visible damage. Chains fixed at both ends, e. g. on fork lift trucks, need to be measured in the working area only.

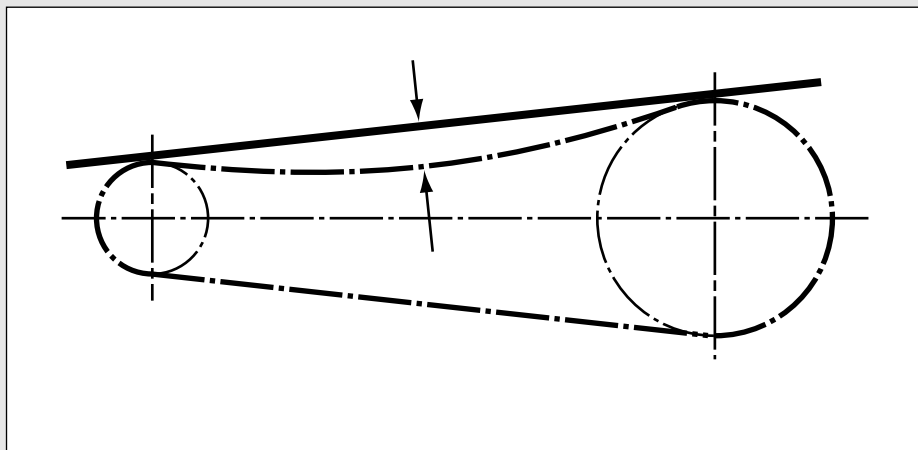

Fig. 8: Chain tension – slack determination.

Excessive noise

Basically chain drives are less noisy than any comparable drives. If a chain drive does appear too noisy faulty design or maintenance is most certainly the cause.

If such problems do arise please consult the Rexnord Engineering Service.

Chain pulsation

In certain conditions chain drives may develop pulsation, in the drive as well as the return strands. Pulsation leads to premature wear and material fatigue as well as noise development.

We must differentiate between vertical and transverse pulsation, in the strand. By fitting guide rails which adjust the drive chain slightly from the normal drive direction as well as a suitable number of teeth a satisfactory solution can be found.

Hydrogen brittleness

If heat treated materials are exposed to hydrogen (chemical description H) the material draws the hydrogen out of the environment. This leads to decomposition of the molecular assembly of the treated steel.

All chains are affected by this as well as roller bearings.

Many chain users might have been surprised by sideplates becoming brittle and resultant deformation without apparent overload.

If hydrogen is present in the environment such damages are unavoidable. Hydrogen develops under the following circumstances for example:

1. Contact between metal and acids, for example $H_2SO_4 + Fe = FeSO_4 + 2 H$.
2. During electrolysis.

It is dangerous to apply the electrolytic process – such as cadmium, chromium or tin plating – to chains already assembled.

However, Rexnord, solves such problems by special procedures during manufacturing.

Chains with metallic surface protection

We would be pleased to submit suitable proposals if special corrosion protection by surface treatment is required.

Manufacture's Lubrication

Standard preservation

All Rexnord chains are protected by a special anti-corrosion coating. This safeguards the chain during storage and transportation, particularly when exporting overseas.

Anticorit TX 8 R – VSK 001

During indoor storage, this product offers protection for at least 12 months. This special preservation aid is applied in a thermostatically controlled bath. When the submerged chain's temperature reaches that of the bath (115 °C) all parts of the chain will be fully coated.

This product is used only for corrosion protection, therefore, we recommend that the chain is lubricated on installation. During each subsequent lubrication it must be ensured that a sufficient quantity of the lubricant reaches the chain joints.

Special lubrication products

For an additional charge Rexnord chains can be equipped with special products.

These special lubricants are applied immediately after chain assembly, to ensure with absolute certainty that the product gets into the chain joints. Stock chains which already have the normal preservation are not suitable for the application of these special products.

In order to avoid long deliveries we ask to advise the desired lubrication timely.

1. Longlife lubrication

For use in textile machinery, paper, packaging, and woodworking machinery as well as conveying equipment we especially recommend the longlife product

Structovis BHD – VSK 006.

This product is fully synthetic of honeylike viscosity and looks. Due to its structural consistency it is not spun off at normal chain speeds.

It is resistant to water and in a lot of applications relubrication is not necessary. This fact deserves special recognition.

Structovis BHD – VSK 006 can be used in temperatures ranging from – 10 to + 150 °C.

2. The longlife lubricant

MKL 32 – VSK 003

is very suitable for chains used in general machinery, bleaching, galvanizing and agricultural industries. With this longlife product relubrication can be avoided as well since at normal chain speeds there is neither spinning off nor can it be absorbed by dirt or dust. This is a solid lubricant containing product with good emergency run characteristics of honeylike viscosity and black-grey colouring. Useful temperature range is from 0 to 180 °C.

3. Wax lubrication

VSK 018

This lubricant has some special properties:

- non drip
- wax structure
- water contamination grade WGK 0
- suitable for food industry
- longlife product
- wear protection
- prevents slip-stick effect
- temperature range – 40 °C to 80 °C

This lubricant is non-toxic and environmentally friendly. Additionally, wax is an excellent corrosion inhibitor.

Testing in an atmospheric chamber to DIN 50017 KFW showed no corrosion after 30 cycles (720 hours). This product also protects against friction, wear, tribo-corrosion, rust and slip-stick. It is especially resistant to the effects of extreme bearing area pressure.

4. High and low temperature lubrication

For temperature ranges from – 40 °C to 250 °C we recommend

Synthesco – VSK 012.

This can be used for chains working in sub-zero temperatures, e. g. lifting equipment in cold storage warehouses. It can also be used in high temperature environments, such as on furnaces and drying equipment.

This thermally stable synthetic oil contains Unimoly which has emergency lubrication properties. This helps in applications where lubrication is limited.

5. High temperature lubrication

Exclusively for high temperature ranges from 0 to 400 °C a suitable product is

Wolfrasyon UL 91 M – VSK 008.

This product contains solid lubricant parts such as graphite and MOS as well as metallic additives for optimum lubrication results at high temperatures. It has excellent emergency lubricating properties. It will not be spun off by the operation of the chain.

6. Increased corrosion protection

In a corrosive environment where special protection is required

Anticorit DW Thix – VSK 011

offers an excellent solution.

This excellent corrosion protective product is also a good lubricant. It is applied in a warm bath and is suitable for use on forklifts, agricultural machinery and in atmospherically aggressive surroundings .

7. Lubrication oil for food industry with USDH-1 approval

4UH1-1500 – VSK 016

for temperature range from – 20°C to 130°C.

This product complies with the German Food Law and Commodity Goods Law (LMBG, 5, Paragraphe 1, Type 1) and it is fulfills the “Guidelines of sec. 21 CFR 178.3570 of FDA Regulations” from USA with USDA H-1 registration. It was specially developed for food industry.

Features: wear resistance, extreme pressure additive, can be used in cold conditions, and good corrosion resistance.

Caution

With the above mentioned products almost all lubrication problems can be overcome. There are, however, a number of applications where specific questions with regard to relubrication arise.

Please consult the technical service of Rexnord. We will be able to advise expertly on all lubrication questions. (If necessary equal products from other manufacturers may be used.)

General

Rexnord's technical customer service team has extensive experience in both practical applications and laboratory research, enabling us to offer effective solutions to your chain drive design requirements.

Make use of our experience.



